



PREGLED SUDJELOVANJA



LIGA ZA DJEČAKE ZGB. ŽUPANIJE- 1. KRUG SL - FS

| R.br. | EKIPA | MJESTO | 27 kg | 29 kg | 32 kg | 35 kg | 38 kg | 42 kg | 47 kg | 53 kg | 59 kg | 66 kg | 78 kg | Ukupno |
|----------------------------|-----------------|-----------------|----------|----------|-----------|-----------|----------|-----------|-----------|-----------|-----------|-----------|----------|------------|
| 1 | BISTRA | BISTRA | | | | | 1 | 2 | 1 | 1 | | | 1 | 6 |
| 2 | BISTRA | ZAGREB | | | | | | | | 1 | | | | 1 |
| 3 | BREZOVICA | BREZOVICA | | 1 | 2 | | | 1 | 2 | 1 | 1 | 2 | 1 | 11 |
| 4 | LIKA | ZAGREB | | | 2 | 1 | | 1 | 1 | | 1 | | | 6 |
| 5 | LOKOMOTIVA | ZAGREB | 1 | | | | | | | | 1 | | | 2 |
| 6 | METALAC | ZAGREB | 1 | 1 | 2 | 2 | 1 | 2 | 2 | 2 | 2 | 2 | 2 | 19 |
| 7 | PIK VRBOVEC | VRBOVEC | | | | 2 | | 2 | | 1 | 1 | 1 | | 7 |
| 8 | SESV. KRALJEVEC | SESV. KRALJEVEC | 1 | 1 | 2 | 2 | 2 | 2 | 2 | 2 | 2 | 2 | 1 | 19 |
| 9 | SESVETE | ZAGREB | | 1 | 2 | 1 | 2 | 2 | 2 | 2 | 1 | 1 | 1 | 15 |
| 10 | SOBLINEC | ZAGREB | | | 1 | 2 | | | 1 | | 1 | 1 | | 6 |
| 11 | ZAGREB | ZAGREB | 1 | 2 | | 2 | 1 | 2 | 2 | 2 | 2 | 2 | 2 | 18 |
| UKUPNO NATJECATELJA | | | 4 | 6 | 11 | 12 | 7 | 14 | 13 | 12 | 12 | 11 | 8 | 110 |

| R.br. | Hrvač | Ekipa | 1 | 2 | 3 | 4 | PP | PL. |
|-------|----------------|-----------------|---|---|---|---|-----------|-----------|
| 1 | ČAČULOVIĆ Leon | SESV. KRALJEVEC | | 5 | 1 | 0 | 6 | 3. |
| 2 | IVANOVIĆ Luka | ZAGREB | 0 | | 0 | 0 | 0 | 4. |
| 3 | AKRAP Božidar | METALAC | 4 | 4 | | 0 | 8 | 2. |
| 4 | ČULE Mark | LOKOMOTIVA | 4 | 4 | 4 | | 12 | 1. |

N1

| | | | | | | | |
|---|---------------|----------------|-----|----------------|----------------|----------------|---|
| 1 | $\frac{5}{7}$ | ČAČULOVIĆ Leon | SKR | $\frac{P1}{7}$ | $\frac{P2}{0}$ | $\frac{P3}{0}$ | } |
| 2 | $\frac{0}{9}$ | IVANOVIĆ Luka | ZGB | $\frac{P1}{9}$ | $\frac{P2}{0}$ | $\frac{P3}{0}$ | |
| 3 | $\frac{0}{0}$ | AKRAP Božidar | MET | $\frac{P1}{0}$ | $\frac{P2}{0}$ | $\frac{P3}{0}$ | } |
| 4 | $\frac{4}{0}$ | ČULE Mark | LOK | $\frac{P1}{0}$ | $\frac{P2}{0}$ | $\frac{P3}{0}$ | |

N2

| | | | | | | | |
|---|---------------|----------------|-----|----------------|----------------|----------------|---|
| 1 | $\frac{1}{0}$ | ČAČULOVIĆ Leon | SKR | $\frac{P1}{0}$ | $\frac{P2}{0}$ | $\frac{P3}{0}$ | } |
| 3 | $\frac{4}{0}$ | AKRAP Božidar | MET | $\frac{P1}{0}$ | $\frac{P2}{0}$ | $\frac{P3}{0}$ | |
| 2 | $\frac{0}{0}$ | IVANOVIĆ Luka | ZGB | $\frac{P1}{0}$ | $\frac{P2}{0}$ | $\frac{P3}{0}$ | } |
| 4 | $\frac{4}{0}$ | ČULE Mark | LOK | $\frac{P1}{0}$ | $\frac{P2}{0}$ | $\frac{P3}{0}$ | |

N3

| | | | | | | | |
|---|---------------|----------------|-----|----------------|----------------|----------------|---|
| 1 | $\frac{0}{0}$ | ČAČULOVIĆ Leon | SKR | $\frac{P1}{0}$ | $\frac{P2}{0}$ | $\frac{P3}{0}$ | } |
| 4 | $\frac{4}{0}$ | ČULE Mark | LOK | $\frac{P1}{0}$ | $\frac{P2}{0}$ | $\frac{P3}{0}$ | |
| 2 | $\frac{0}{0}$ | IVANOVIĆ Luka | ZGB | $\frac{P1}{0}$ | $\frac{P2}{0}$ | $\frac{P3}{0}$ | } |
| 3 | $\frac{4}{0}$ | AKRAP Božidar | MET | $\frac{P1}{0}$ | $\frac{P2}{0}$ | $\frac{P3}{0}$ | |

KONAČNI POREDAK

| Plasman | Hrvač | Ekipa |
|---------|----------------|-------|
| 1 | ČULE Mark | LOK |
| 2 | AKRAP Božidar | MET |
| 3 | ČAČULOVIĆ Leon | SKR |
| 4 | IVANOVIĆ Luka | ZGB |



TABLICA ELIMINACIJE

LIGA ZA DJEČAKE ZGB. ŽUPANIJE- 1. KRUG SL - FS - 29 kg



Q

| | | | | | | |
|---|---------------|-----------------|-----|----|----|----|
| 3 | $\frac{3}{9}$ | PERKOVIĆ Robert | ZGB | P1 | P2 | P3 |
| | | | | 4 | 5 | 0 |
| 4 | $\frac{1}{4}$ | SUPINA Damjan | ZGB | P1 | P2 | P3 |
| | | | | 2 | 2 | 0 |
| 5 | $\frac{0}{0}$ | ŽILJAK Dominik | SKR | P1 | P2 | P3 |
| | | | | 0 | 0 | 0 |
| 6 | $\frac{5}{4}$ | ĆORLUKA Franjo | MET | P1 | P2 | P3 |
| | | | | 4 | 0 | 0 |

1/2 F

| | | | | | | |
|---|---------------|-------------------|-----|----|----|----|
| 1 | $\frac{5}{0}$ | IVANČIĆ Luka | SES | P1 | P2 | P3 |
| | | | | 0 | 0 | 0 |
| 2 | $\frac{0}{0}$ | DEANOVIĆ Krešimir | BRE | P1 | P2 | P3 |
| | | | | 0 | 0 | 0 |
| 3 | $\frac{0}{0}$ | PERKOVIĆ Robert | ZGB | P1 | P2 | P3 |
| | | | | 0 | 0 | 0 |
| 6 | $\frac{5}{0}$ | ĆORLUKA Franjo | MET | P1 | P2 | P3 |
| | | | | 0 | 0 | 0 |

F 1-2

| | | | | | | |
|---|---------------|----------------|-----|----|----|----|
| 1 | $\frac{5}{0}$ | IVANČIĆ Luka | SES | P1 | P2 | P3 |
| | | | | 0 | 0 | 0 |
| 1 | | IVANČIĆ Luka | SES | | | |
| | | | | | | |
| | | | | | | |
| | | | | | | |
| 6 | $\frac{0}{0}$ | ĆORLUKA Franjo | MET | P1 | P2 | P3 |
| | | | | 0 | 0 | 0 |

Repechage B

| | | | | | | |
|---|---------------|-----------------|-----|----|----|----|
| 5 | $\frac{0}{0}$ | ŽILJAK Dominik | SKR | P1 | P2 | P3 |
| | | | | 0 | 0 | 0 |
| 3 | | PERKOVIĆ Robert | ZGB | | | |
| | | | | | | |
| | | | | | | |
| 3 | $\frac{5}{0}$ | PERKOVIĆ Robert | ZGB | P1 | P2 | P3 |
| | | | | 0 | 0 | 0 |

KONAČNI POREDAK

| Plasman | Hrvač | Ekipa |
|---------|-------------------|--------|
| 1 | IVANČIĆ Luka | SES |
| 2 | ĆORLUKA Franjo | MET |
| 3 | DEANOVIĆ Krešimir | BREZOV |
| 3 | PERKOVIĆ Robert | ZGB |
| 5 | ŽILJAK Dominik | SKR |
| 6 | SUPINA Damjan | ZGB |



TABLICA ELIMINACIJE

LIGA ZA DJEČAKE ZGB. ŽUPANIJE- 1. KRUG SL - FS - 32 kg

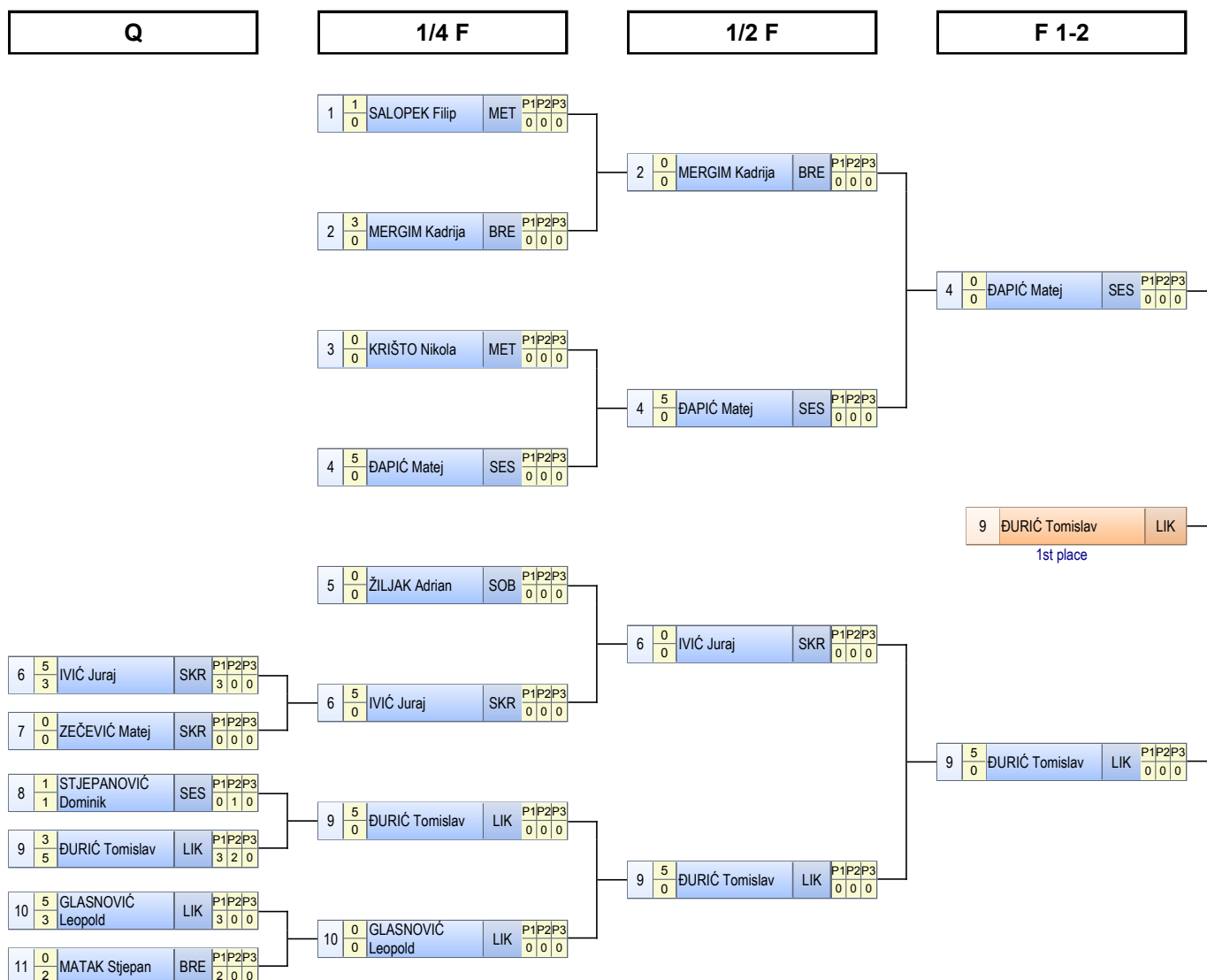

9 ĐURIĆ Tomislav LIK
1st place

KONAČNI POREDAK

| Plasman | Hrvač | Ekipa |
|---------|---------------------|--------|
| 1 | ĐURIĆ Tomislav | LIKA |
| 2 | ĐAPIĆ Matej | SES |
| 3 | MERGIM Kadrija | BREZOV |
| 3 | IVIĆ Juraj | SKR |
| 5 | KRIŠTO Nikola | MET |
| 5 | STJEPANOVIĆ Dominik | SES |
| 7 | GLASNOVIĆ Leopold | LIKA |
| 8 | SALOPEK Filip | MET |
| 9 | MATAK Stjepan | BREZOV |
| 10 | ŽILJAK Adrian | SOB |
| 11 | ZEČEVIĆ Matej | SKR |

Repechage A

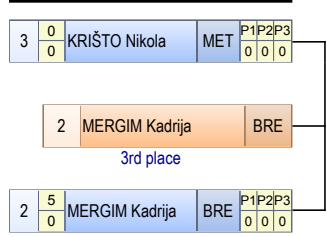

Repechage B

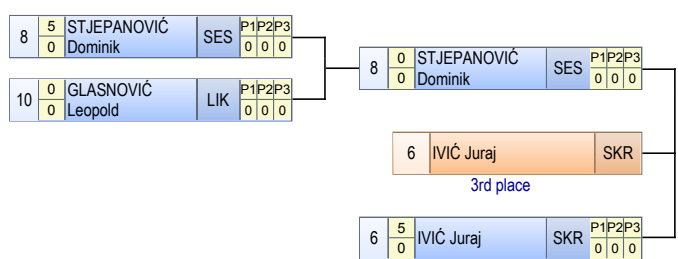



TABLICA ELIMINACIJE

LIGA ZA DJEČAKE ZGB. ŽUPANIJE- 1. KRUG SL - FS - 35 kg

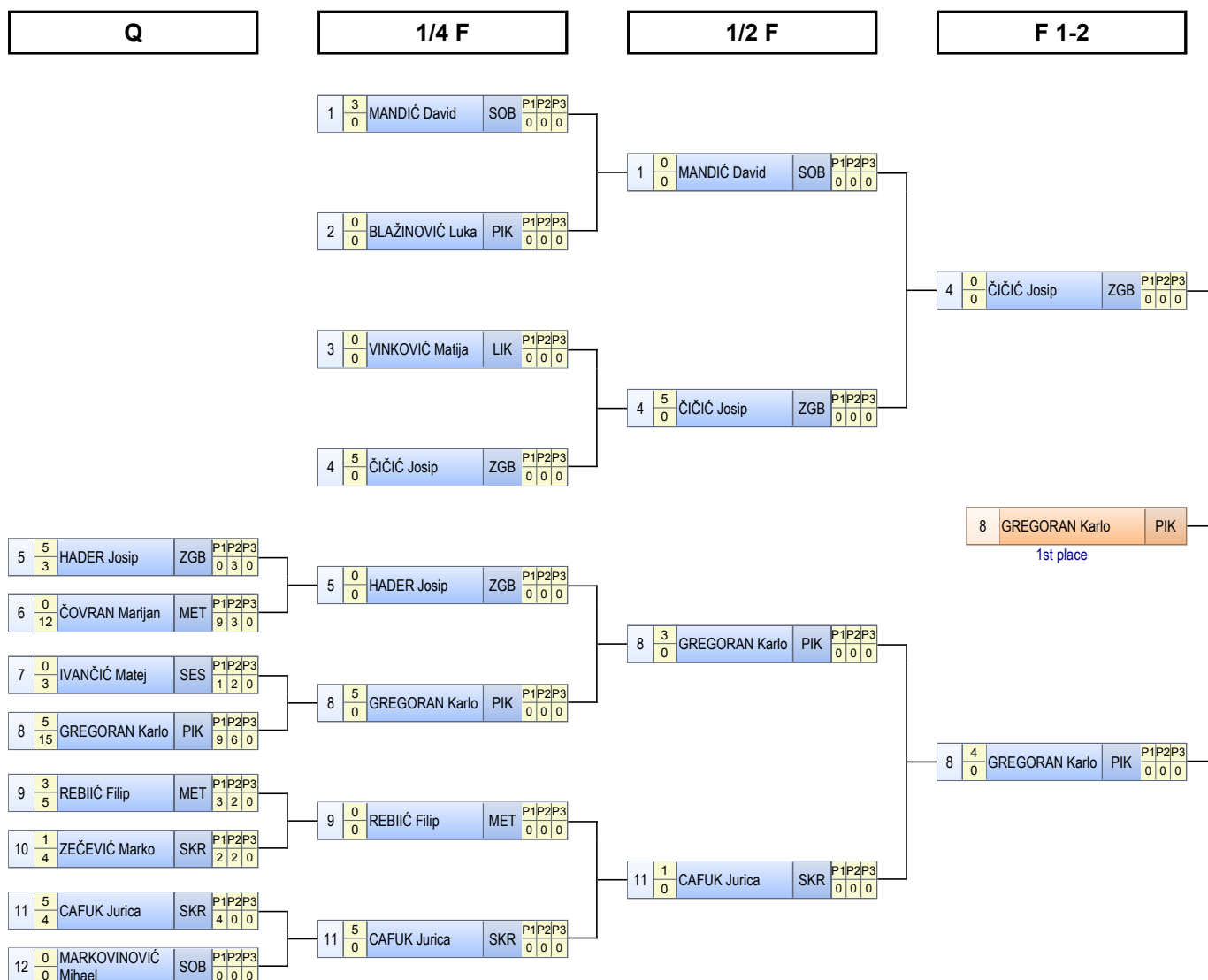

KONAČNI POREDAK

| Plasman | Hrvač | Ekipa |
|---------|---------------------|-------|
| 1 | GREGORAN Karlo | PIKV |
| 2 | ČIČIĆ Josip | ZGB |
| 3 | VINKOVIĆ Matija | LIKA |
| 3 | CAFUK Jurica | SKR |
| 5 | MANDIĆ David | SOB |
| 5 | HADER Josip | ZGB |
| 7 | REBIĆ Filip | MET |
| 8 | ZEČEVIĆ Marko | SKR |
| 9 | ČOVTRAN Marijan | MET |
| 10 | IVANČIĆ Matej | SES |
| 11 | BLAŽINOVIĆ Luka | PIKV |
| 12 | MARKOVINOVIĆ Mihael | SOB |

Repechage A

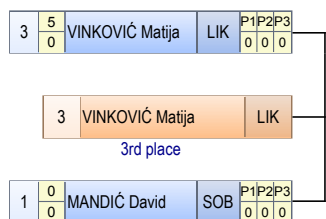

Repechage B

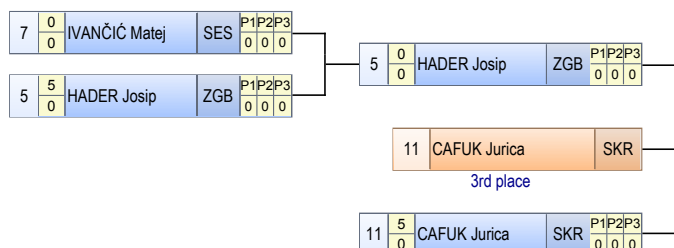



TABLICA ELIMINACIJE

LIGA ZA DJEČAKE ZGB. ŽUPANIJE- 1. KRUG SL - FS - 38 kg



Q

| | | | | |
|---|------|-------------------|-----|-----------------|
| 2 | 0/0 | STAJČIĆ Filip | MET | P1P2P3 0 0 0 |
| 3 | 5/3 | KUŠIĆ Fran | SES | P1P2P3 3 0 0 |
| 4 | 5/3 | PRIHISTAL Luka | BIS | P1P2P3 3 0 0 |
| 5 | 0/0 | RAIĆ Ante | SKR | P1P2P3 0 0 0 |
| 6 | 3/10 | BOŠNJAK Kristijan | ZGB | P1P2P3 6 4 0 |
| 7 | 1/3 | PLEČKO Lovro | SKR | P1P2P3 0 3 0 |

1/2 F

| | | | | |
|---|-----|-------------------|-----|-----------------|
| 1 | 1/0 | SABLJIĆ Karlo | SES | P1P2P3 0 0 0 |
| 3 | 3/0 | KUŠIĆ Fran | SES | P1P2P3 0 0 0 |
| 4 | 5/0 | PRIHISTAL Luka | BIS | P1P2P3 0 0 0 |
| 6 | 0/0 | BOŠNJAK Kristijan | ZGB | P1P2P3 0 0 0 |

F 1-2

| | | | | |
|-----------|-----|----------------|-----|-----------------|
| 3 | 3/0 | KUŠIĆ Fran | SES | P1P2P3 0 0 0 |
| 3 | | KUŠIĆ Fran | SES | |
| 1st place | | | | |
| 4 | 1/0 | PRIHISTAL Luka | BIS | P1P2P3 0 0 0 |

Repechage A

| | | | | |
|-----------|-----|---------------|-----|-----------------|
| 2 | 0/0 | STAJČIĆ Filip | MET | P1P2P3 0 0 0 |
| 1 | | SABLJIĆ Karlo | SES | |
| 3rd place | | | | |
| 1 | 5/0 | SABLJIĆ Karlo | SES | P1P2P3 0 0 0 |

Repechage B

| | | | | |
|-----------|-----|-------------------|-----|-----------------|
| 5 | 3/0 | RAIĆ Ante | SKR | P1P2P3 0 0 0 |
| 5 | | RAIĆ Ante | SKR | |
| 3rd place | | | | |
| 6 | 1/0 | BOŠNJAK Kristijan | ZGB | P1P2P3 0 0 0 |

KONAČNI POREDAK

| Plasman | Hrvač | Ekipa |
|---------|-------------------|-------|
| 1 | KUŠIĆ Fran | SES |
| 2 | PRIHISTAL Luka | BIS |
| 3 | SABLJIĆ Karlo | SES |
| 3 | RAIĆ Ante | SKR |
| 5 | STAJČIĆ Filip | MET |
| 5 | BOŠNJAK Kristijan | ZGB |
| 7 | PLEČKO Lovro | SKR |



TABLICA ELIMINACIJE

LIGA ZA DJEČAKE ZGB. ŽUPANIJE- 1. KRUG SL - FS - 42 kg

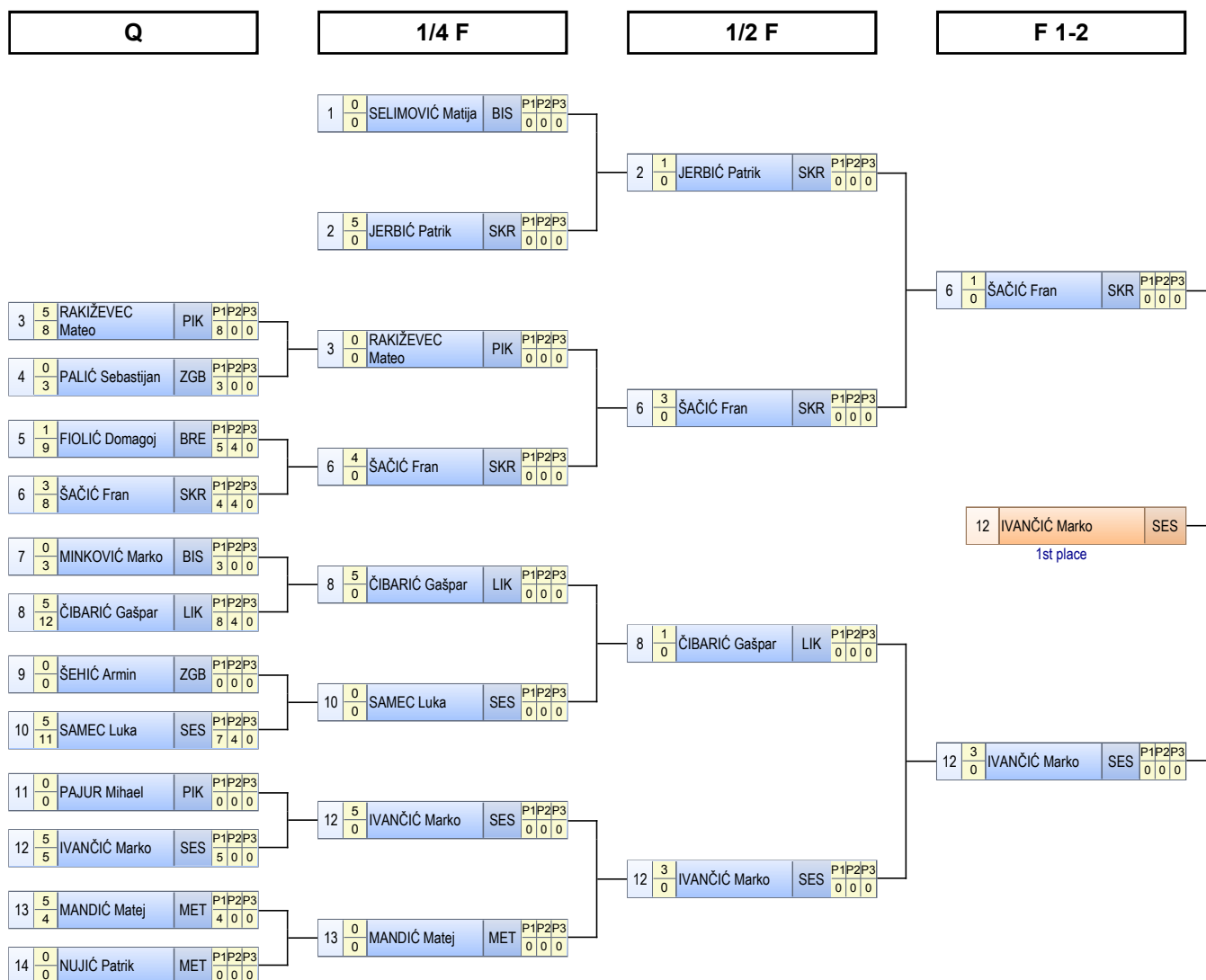

KONAČNI POREDAK

| Plasman | Hrvač | Ekipa |
|---------|------------------|--------|
| 1 | IVANČIĆ Marko | SES |
| 2 | ŠAČIĆ Fran | SKR |
| 3 | FIOLIĆ Domagoj | BREZOV |
| 3 | MANDIĆ Matej | MET |
| 5 | JERBIĆ Patrik | SKR |
| 5 | ČIBARIĆ Gašpar | LIKA |
| 7 | SAMEC Luka | SES |
| 8 | RAKIŽEVEC Mateo | PIKV |
| 9 | PALIĆ Sebastijan | ZGB |
| 10 | MINKOVIĆ Marko | BIS |
| 11 | SELIMOVIĆ Matija | BIS |
| 12 | NUJIĆ Patrik | MET |
| 13 | PAJUR Mihael | PIKV |
| 14 | ŠEHIĆ Armin | ZGB |

Repechage A

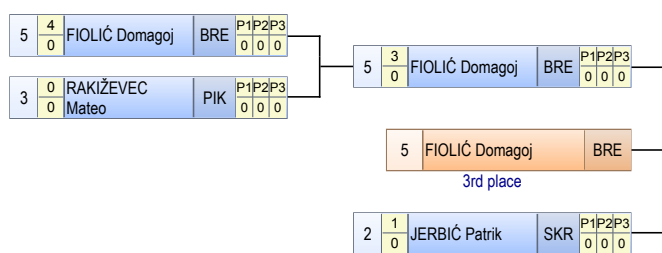

Repechage B

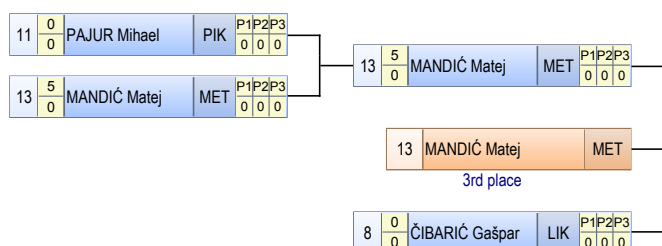



TABLICA ELIMINACIJE

LIGA ZA DJEČAKE ZGB. ŽUPANIJE- 1. KRUG SL - FS - 47 kg

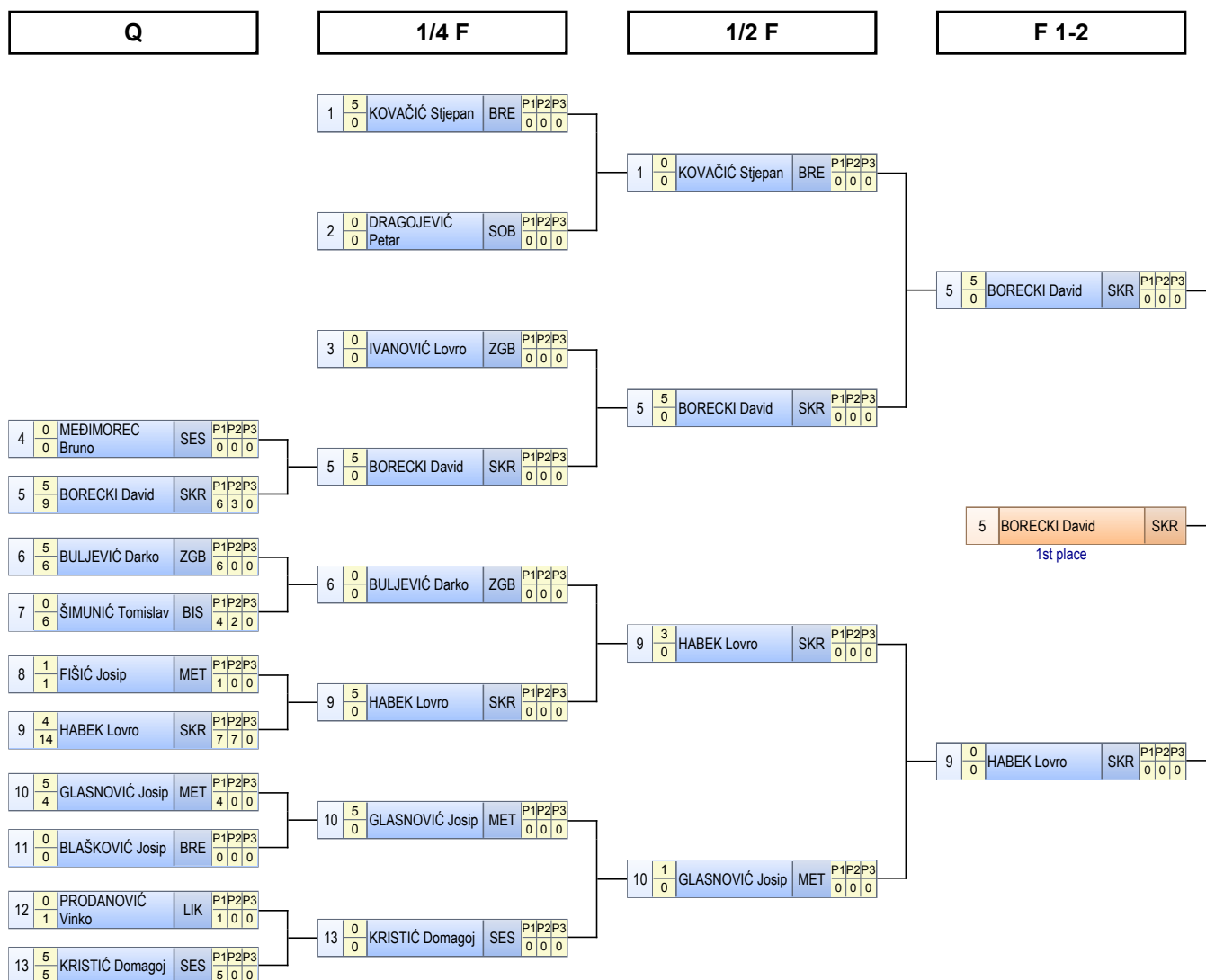

KONAČNI POREDAK

| Plasman | Hrvač | Ekipa |
|---------|------------------|--------|
| 1 | BORECKI David | SKR |
| 2 | HABEK Lovro | SKR |
| 3 | KOVAČIĆ Stjepan | BREZOV |
| 3 | GLASNOVIĆ Josip | MET |
| 5 | MEDIMOREC Bruno | SES |
| 5 | FIŠIĆ Josip | MET |
| 7 | BULJEVIĆ Darko | ZGB |
| 8 | KRISTIĆ Domagoj | SES |
| 9 | ŠIMUNIĆ Tomislav | BIS |
| 10 | PRODANOVIĆ Vinko | LIKA |
| 11 | DRAGOJEVIĆ Petar | SOB |
| 11 | IVANOVIĆ Lovro | ZGB |
| 13 | BLAŠKOVIĆ Josip | BREZOV |

Repechage A

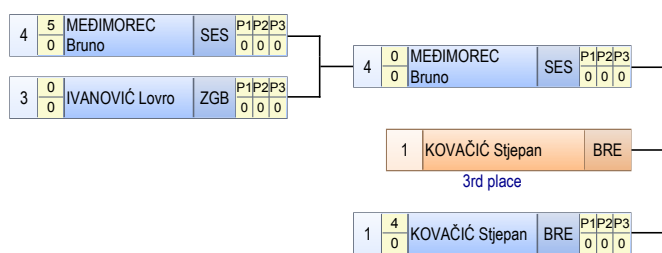

Repechage B

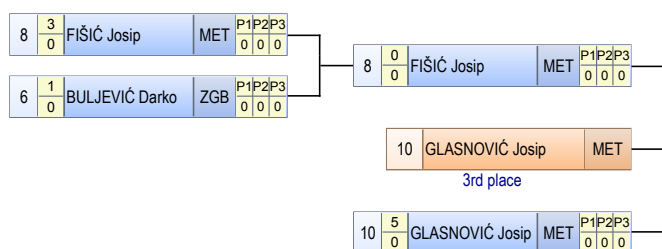



TABLICA ELIMINACIJE

LIGA ZA DJEČAKE ZGB. ŽUPANIJE- 1. KRUG SL - FS - 53 kg

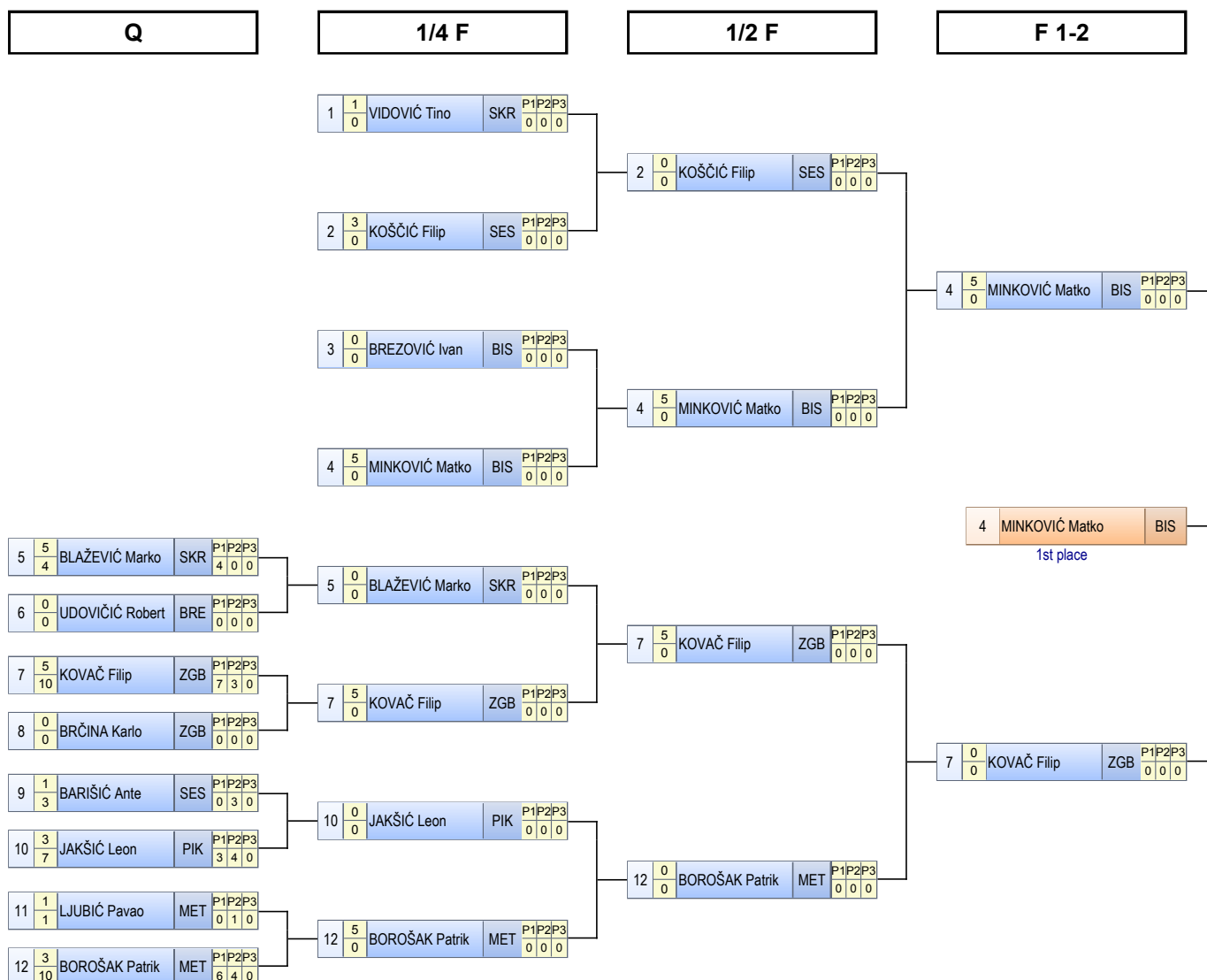

KONAČNI POREDAK

Repechage A

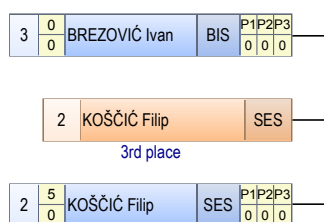

Repechage B

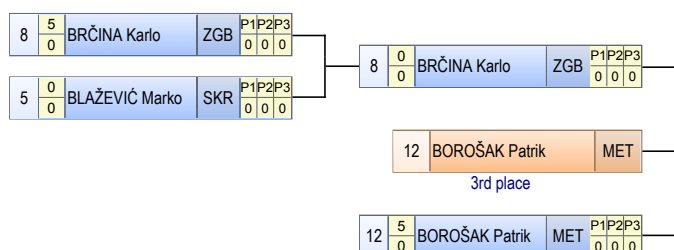

| Plasman | Hrvač | Ekipa |
|---------|-----------------|--------|
| 1 | MINKOVIĆ Matko | BIST |
| 2 | KOVAČ Filip | ZGB |
| 3 | KOŠČIĆ Filip | SES |
| 3 | BOROŠAK Patrik | MET |
| 5 | BREZOVIĆ Ivan | BIS |
| 5 | BRČINA Karlo | ZGB |
| 7 | BLAŽEVIĆ Marko | SKR |
| 8 | JAKŠIĆ Leon | PIKV |
| 9 | BARIŠIĆ Ante | SES |
| 10 | LJUBIĆ Pavao | MET |
| 11 | VIDOVIĆ Tino | SKR |
| 12 | UDOVIČIĆ Robert | BREZOV |



TABLICA ELIMINACIJE

LIGA ZA DJEČAKE ZGB. ŽUPANIJE- 1. KRUG SL - FS - 59 kg

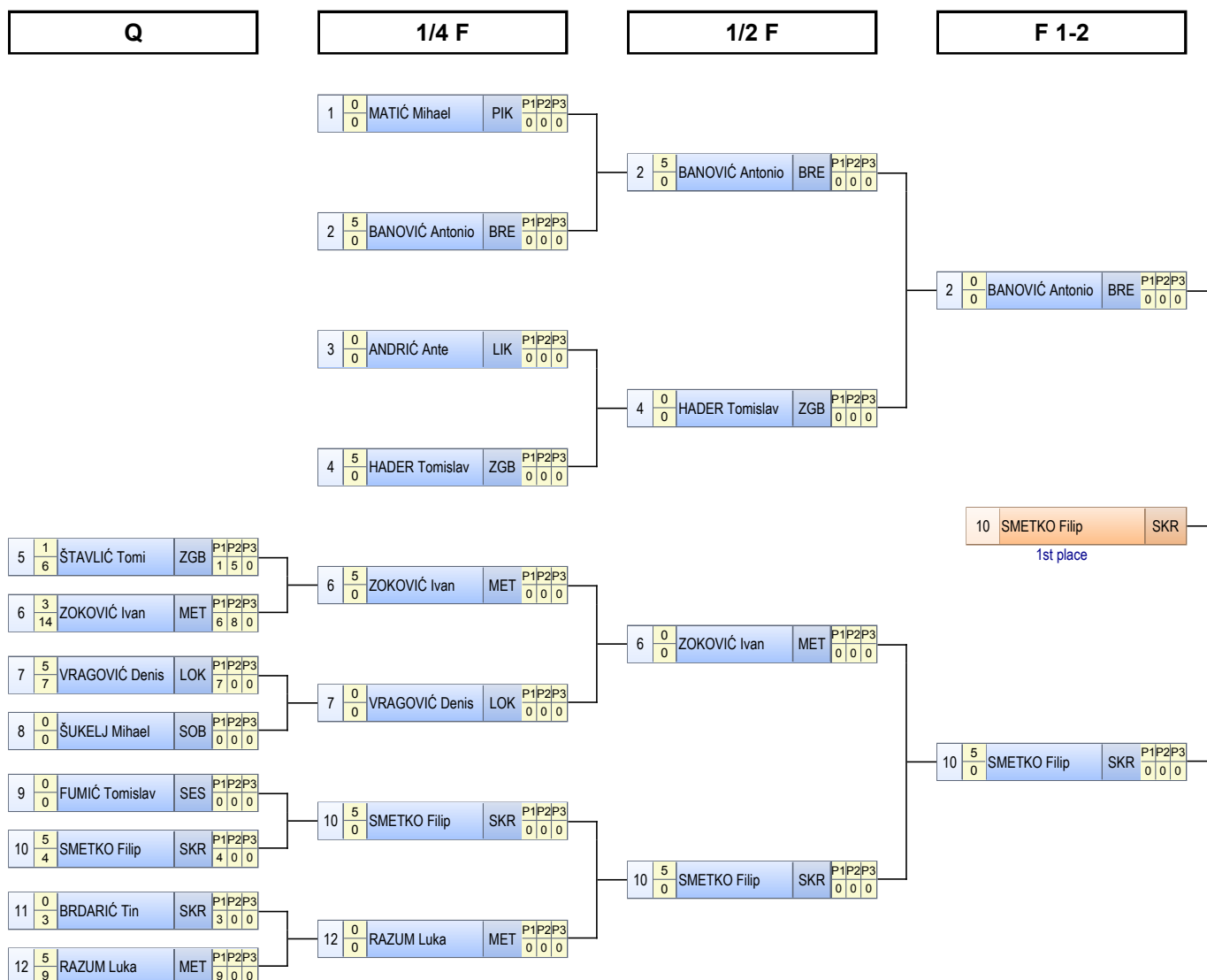

KONAČNI POREDAK

Repechage A



Repechage B

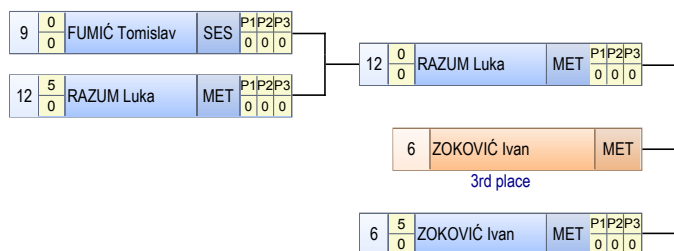

| Plasman | Hrvač | Ekipa |
|---------|-----------------|--------|
| 1 | SMETKO Filip | SKR |
| 2 | BANOVIĆ Antonio | BREZOV |
| 3 | HADER Tomislav | ZGB |
| 3 | ZOKOVIĆ Ivan | MET |
| 5 | MATIĆ Mihael | PIKV |
| 5 | RAZUM Luka | MET |
| 7 | VRAGOVIĆ Denis | LOK |
| 8 | ŠTAVLIĆ Tomi | ZGB |
| 9 | BRDARIĆ Tin | SKR |
| 10 | ANDRIĆ Ante | LIKA |
| 11 | FUMIĆ Tomislav | SES |
| 12 | ŠUKELJ Mihael | SOB |



TABLICA ELIMINACIJE

LIGA ZA DJEČAKE ZGB. ŽUPANIJE- 1. KRUG SL - FS - 66 kg

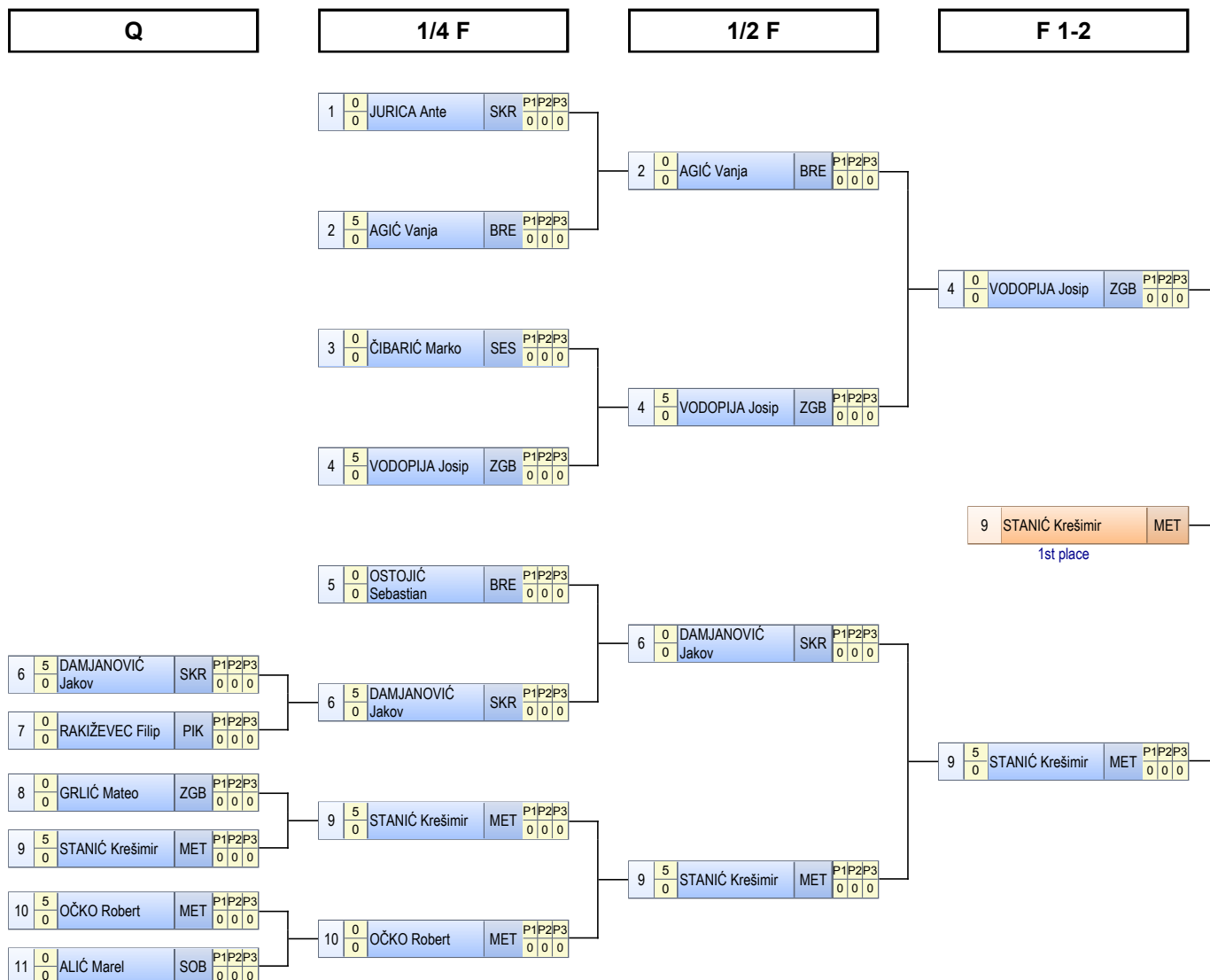

KONAČNI POREDAK

| Plasman | Hrvač | Ekpa |
|---------|-------------------|--------|
| 1 | STANIĆ Krešimir | MET |
| 2 | VODOPIJA Josip | ZGB |
| 3 | AGIĆ Vanja | BREZOV |
| 3 | OČKO Robert | MET |
| 5 | ČIBARIĆ Marko | SES |
| 5 | DAMJANOVIĆ Jakov | SKR |
| 7 | JURICA Ante | SKR |
| 7 | OSTOJIĆ Sebastian | BREZOV |
| 7 | RAKIŽEVEC Filip | PIKV |
| 7 | GRLIĆ Mateo | ZGB |
| 7 | ALIĆ Marel | SOB |

Repechage A

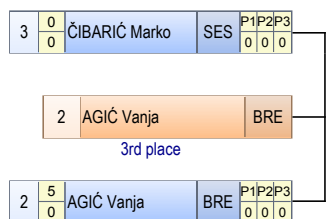

Repechage B

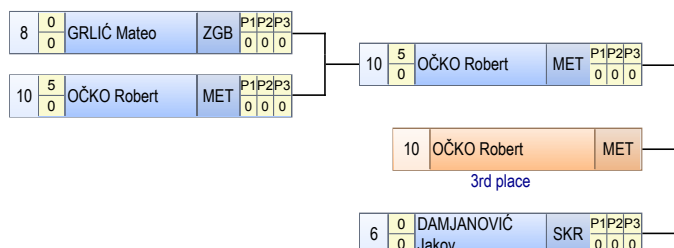



TABLICA ELIMINACIJE

LIGA ZA DJEČAKE ZGB. ŽUPANIJE- 1. KRUG SL - FS - 78 kg

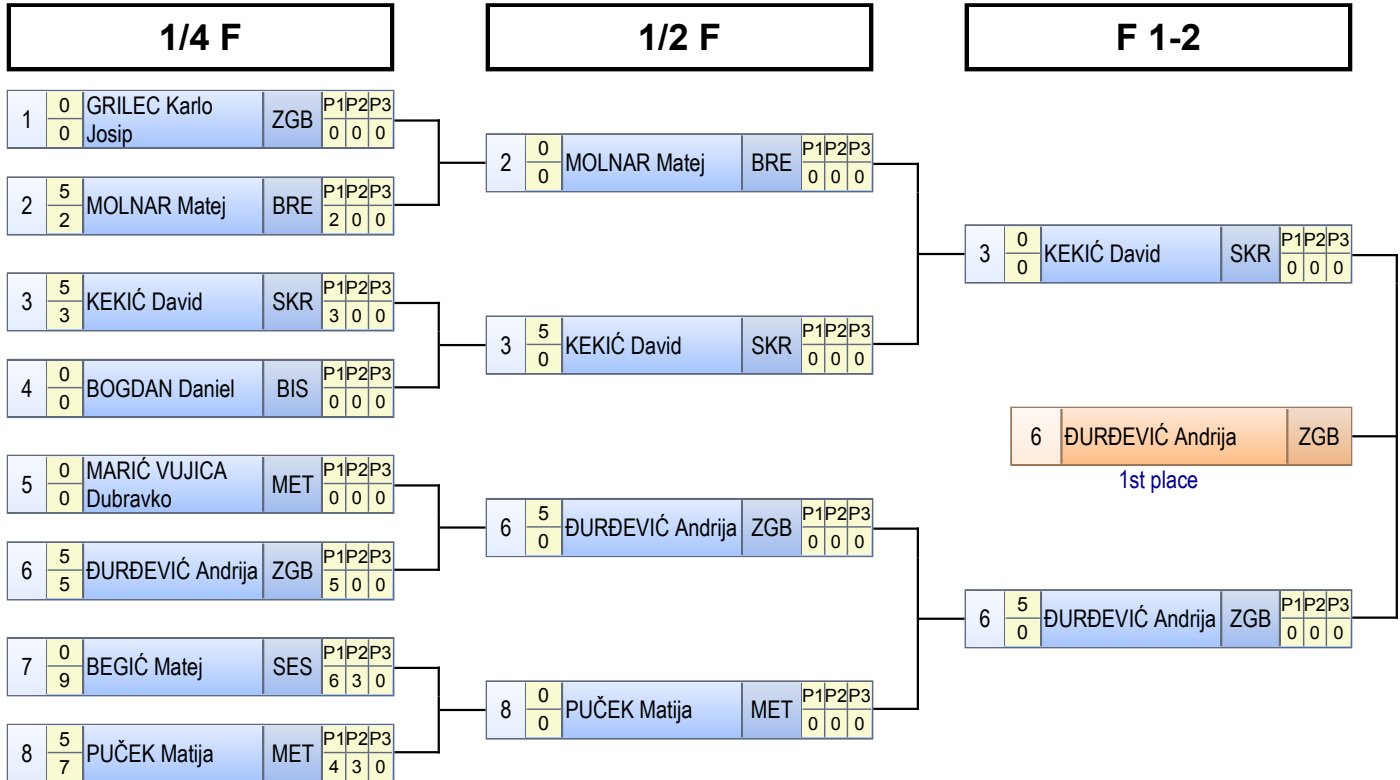

KONAČNI POREDAK

| Plasman | Hrvač | Ekipa |
|---------|-----------------------|--------|
| 1 | ĐURĐEVIĆ Andrija | ZGB |
| 2 | KEKIĆ David | SKR |
| 3 | MOLNAR Matej | BREZOV |
| 3 | MARIĆ VUJICA Dubravko | MET |
| 5 | BOGDAN Daniel | BIS |
| 5 | PUČEK Matija | MET |
| 7 | BEGIĆ Matej | SES |
| 8 | GRILEC Karlo Josip | ZGB |

Repechage A

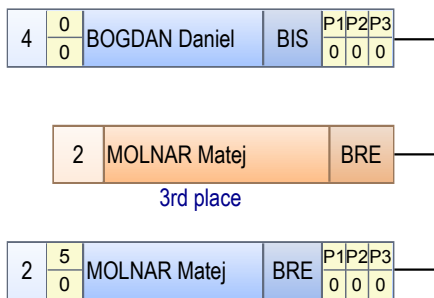

Repechage B

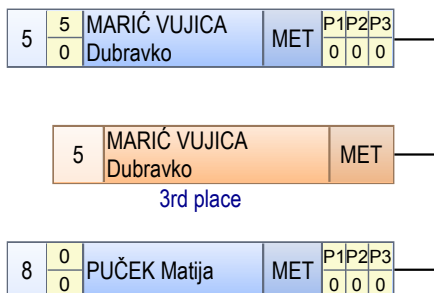



POJEDINAČNI POREDAK PO KATEGORIJAMA



LIGA ZA DJEČAKE ZGB. ŽUPANIJE- 1. KRUG SL - FS

| 27 kg | | | |
|-------|----------------|-----------------|-------------|
| 1 | ČULE Mark | LOKOMOTIVA | 7.0 |
| 2 | AKRAP Božidar | METALAC | 5.0 |
| 3 | ČAČULOVIĆ Leon | SESV. KRALJEVEC | 3.5 |
| 4 | IVANOVIĆ Luka | ZAGREB | 3.5 |
| | | | 19.0 |

| 29 kg | | | |
|-------|-------------------|-----------------|-------------|
| 1 | IVANČIĆ Luka | SESVETE | 7.0 |
| 2 | ĆORLUKA Franjo | METALAC | 5.0 |
| 3 | DEANOVIĆ Krešimir | BREZOVICA | 3.5 |
| 3 | PERKOVIĆ Robert | ZAGREB | 3.5 |
| 5 | ŽILJAK Dominik | SESV. KRALJEVEC | 1.5 |
| 6 | SUPINA Damjan | ZAGREB | 1.5 |
| | | | 22.0 |

| 32 kg | | | |
|-------|---------------------|-----------------|-------------|
| 1 | ĐURIĆ Tomislav | LIKA | 7.0 |
| 2 | ĐAPIĆ Matej | SESVETE | 5.0 |
| 3 | MERGIM Kadrija | BREZOVICA | 3.5 |
| 3 | IVIĆ Juraj | SESV. KRALJEVEC | 3.5 |
| 5 | KRIŠTO Nikola | METALAC | 1.5 |
| 5 | STJEPANOVIĆ Dominik | SESVETE | 1.5 |
| | | | 22.0 |

| 35 kg | | | |
|-------|-----------------|-----------------|-------------|
| 1 | GREGORAN Karlo | PIK VRBOVEC | 7.0 |
| 2 | ČIČIĆ Josip | ZAGREB | 5.0 |
| 3 | VINKOVIĆ Matija | LIKA | 3.5 |
| 3 | CAFUK Jurica | SESV. KRALJEVEC | 3.5 |
| 5 | MANDIĆ David | SOBLINEC | 1.5 |
| 5 | HADER Josip | ZAGREB | 1.5 |
| | | | 22.0 |

| 38 kg | | | |
|-------|-------------------|-----------------|-------------|
| 1 | KUŠIĆ Fran | SESVETE | 7.0 |
| 2 | PRIHISTAL Luka | BISTRA | 5.0 |
| 3 | SABLJIĆ Karlo | SESVETE | 3.5 |
| 3 | RAIĆ Ante | SESV. KRALJEVEC | 3.5 |
| 5 | STAJČIĆ Filip | METALAC | 1.5 |
| 5 | BOŠNJAK Kristijan | ZAGREB | 1.5 |
| | | | 22.0 |

| 42 kg | | | |
|-------|----------------|-----------------|-------------|
| 1 | IVANČIĆ Marko | SESVETE | 7.0 |
| 2 | ŠAČIĆ Fran | SESV. KRALJEVEC | 5.0 |
| 3 | FIOLIĆ Domagoj | BREZOVICA | 3.5 |
| 3 | MANDIĆ Matej | METALAC | 3.5 |
| 5 | JERBIĆ Patrik | SESV. KRALJEVEC | 1.5 |
| 5 | ČIBARIĆ Gašpar | LIKA | 1.5 |
| | | | 22.0 |

| 47 kg | | | |
|-------|-----------------|-----------------|-----|
| 1 | BORECKI David | SESV. KRALJEVEC | 7.0 |
| 2 | HABEK Lovro | SESV. KRALJEVEC | 5.0 |
| 3 | KOVAČIĆ Stjepan | BREZOVICA | 3.5 |
| 3 | GLASNOVIĆ Josip | METALAC | 3.5 |
| 5 | MEĐIMOREC Bruno | SESVETE | 1.5 |
| 5 | FIŠIĆ Josip | METALAC | 1.5 |



POJEDINAČNI POREDAK PO KATEGORIJAMA



LIGA ZA DJEČAKE ZGB. ŽUPANIJE- 1. KRUG SL - FS

| | | | | 22.0 |
|--------------|-----------------------|-----------------|-----|------|
| 53 kg | | | | |
| 1 | MINKOVIĆ Matko | BISTRA | 7.0 | |
| 2 | KOVAČ Filip | ZAGREB | 5.0 | |
| 3 | KOŠČIĆ Filip | SESVETE | 3.5 | |
| 3 | BOROŠAK Patrik | METALAC | 3.5 | |
| 5 | BREZOVIĆ Ivan | BISTRA | 1.5 | |
| 5 | BRČINA Karlo | ZAGREB | 1.5 | |
| | | | | 22.0 |
| 59 kg | | | | |
| 1 | SMETKO Filip | SESV. KRALJEVEC | 7.0 | |
| 2 | BANOVIĆ Antonio | BREZOVICA | 5.0 | |
| 3 | HADER Tomislav | ZAGREB | 3.5 | |
| 3 | ZOKOVIĆ Ivan | METALAC | 3.5 | |
| 5 | MATIĆ Mihael | PIK VRBOVEC | 1.5 | |
| 5 | RAZUM Luka | METALAC | 1.5 | |
| | | | | 22.0 |
| 66 kg | | | | |
| 1 | STANIĆ Krešimir | METALAC | 7.0 | |
| 2 | VODOPIJA Josip | ZAGREB | 5.0 | |
| 3 | AGIĆ Vanja | BREZOVICA | 3.5 | |
| 3 | OČKO Robert | METALAC | 3.5 | |
| 5 | ČIBARIĆ Marko | SESVETE | 1.5 | |
| 5 | DAMJANOVIĆ Jakov | SESV. KRALJEVEC | 1.5 | |
| | | | | 22.0 |
| 78 kg | | | | |
| 1 | ĐURĐEVIĆ Andrija | ZAGREB | 7.0 | |
| 2 | KEKIĆ David | SESV. KRALJEVEC | 5.0 | |
| 3 | MOLNAR Matej | BREZOVICA | 3.5 | |
| 3 | MARIĆ VUJICA Dubravko | METALAC | 3.5 | |
| 5 | BOGDAN Daniel | BISTRA | 1.5 | |
| 5 | PUČEK Matija | METALAC | 1.5 | |
| | | | | 22.0 |