



PREGLED SUDJELOVANJA

Kvalifikacije za Božićni turnir 2016

DJE GR



R.br.	EKIPA	MJESTO	32 kg	35 kg	38 kg	42 kg	47 kg	53 kg	59 kg	66 kg	73 kg	85 kg	Ukupno
1	BISTRA	BISTRA					1						1
2	GOSPIĆ	GOSPIĆ			1	2	1	1					5
3	HERKUL	ZAGREB			1					1			2
4	HRVATSKI DRAGOVOLJAC	ZAGREB				1		4	1		1	1	8
5	KLINČA SELA	KLINČA SELA				1	1					1	3
6	LIKA	ZAGREB					2				1		3
7	LOKOMOTIVA	ZAGREB					1			1			2
8	LUDBREG	LUDBREG			1		1	1					3
9	METALAC	ZAGREB					2	1	4	3	1		11
10	PETRINJA	PETRINJA				2					1		3
11	PIK VRBOVEC	VRBOVEC	1				1	1	1		1		5
12	SESVETE	ZAGREB			2	1						1	4
13	SESVETSKI KRALJEVEC	SESV. KRALJEVEC		1							1	1	3
14	SISAK	SISAK						1					1
15	SLATINA	SLATINA		1		1	1		1				4
16	ŠIBENIK	ŠIBENIK						1					1



PREGLED SUDJELOVANJA

Kvalifikacije za Božićni turnir 2016

DJE GR



R.br.	EKIPA	MJESTO	32 kg	35 kg	38 kg	42 kg	47 kg	53 kg	59 kg	66 kg	73 kg	85 kg	Ukupno
17	TREŠNJEVKA	ZAGREB							1				1
18	VINDIJA	VARAŽDIN		1		1							2
19	ZAGREB	ZAGREB	1				1	1		3			6
UKUPNO NATJECATELJA			2	3	5	9	12	11	8	8	6	4	68

R.br.	Hrvač	Ekipa	1	2	PP	PL.
1	MIHALIC Matej	PIK VRBOVEC		0	0	2.
2	BOŠNJAK Robert	ZAGREB	4		4	1.

N1						
1	0	MIHALIC Matej	PIK	P1	P2	P3
	0			0	0	
2	4	BOŠNJAK Robert	ZGB	P1	P2	P3
	0			0	0	

KONAČNI POREDAK

Plasman	Hrvač	Ekipa
1	BOŠNJAK Robert	ZGB
2	MIHALIC Matej	PIKV

R.br.	Hrvač	Ekipa	1	2	3	PP	PL.
1	OSMANOVIĆ Renato	SESVETSKI KRALJ		4	4	8	1.
2	ĆOSIĆ Tomislav	VINDIJA	0		0	0	3.
3	GARDILO Ivan	SLATINA	0	4		4	2.

N1						
1	4 0	OSMANOVIĆ Renato	SKR	P1 0	P2 0	P3 0
2	0 0	ĆOSIĆ Tomislav	VIN	P1 0	P2 0	P3 0

N2						
3	0 0	GARDILO Ivan	SLA	P1 0	P2 0	P3 0
1	4 0	OSMANOVIĆ Renato	SKR	P1 0	P2 0	P3 0

N3						
2	0 0	ĆOSIĆ Tomislav	VIN	P1 0	P2 0	P3 0
3	4 0	GARDILO Ivan	SLA	P1 0	P2 0	P3 0

KONAČNI POREDAK

Plasman	Hrvač	Ekipa
1	OSMANOVIĆ Renato	SKR
2	GARDILO Ivan	SLAT
3	ĆOSIĆ Tomislav	VIND

R.br.	Hrvač	Ekipa	1	2	3	4	5	PP	PL.
1	PALATINUŠ Ivan	SESVETE		4	5	4	4	17	1.
2	HABRKA Petar	LUDBREG	0		0	0	4	4	4.
3	REBIĆ MATEJ	HERKUL	0	4		4	5	13	2.
4	KRISTIČEVIĆ Vito	SESVETE	0	5	0		5	10	3.
5	RADOŠEVIĆ Frane	GOSPIĆ	0	0	0	0		0	5.

N1

1	4	PALATINUŠ Ivan	SES	P1P2P3	0 0 0
2	0	HABRKA Petar	LUD	P1P2P3	0 0 0

3	4	REBIĆ MATEJ	HER	P1P2P3	0 0 0
4	0	KRISTIČEVIĆ Vito	SES	P1P2P3	0 0 0

N2

5	0	RADOŠEVIĆ Frane	GS	P1P2P3	0 0 0
1	4	PALATINUŠ Ivan	SES	P1P2P3	0 0 0

2	0	HABRKA Petar	LUD	P1P2P3	0 0 0
3	4	REBIĆ MATEJ	HER	P1P2P3	0 0 0

N3

4	0	KRISTIČEVIĆ Vito	SES	P1P2P3	0 0 0
1	4	PALATINUŠ Ivan	SES	P1P2P3	0 0 0

5	0	RADOŠEVIĆ Frane	GS	P1P2P3	0 0 0
2	4	HABRKA Petar	LUD	P1P2P3	0 0 0

N4

3	0	REBIĆ MATEJ	HER	P1P2P3	0 0 0
1	5	PALATINUŠ Ivan	SES	P1P2P3	0 0 0

4	5	KRISTIČEVIĆ Vito	SES	P1P2P3	0 0 0
5	0	RADOŠEVIĆ Frane	GS	P1P2P3	0 0 0

N5

2	0	HABRKA Petar	LUD	P1P2P3	0 0 0
4	5	KRISTIČEVIĆ Vito	SES	P1P2P3	0 0 0

3	5	REBIĆ MATEJ	HER	P1P2P3	0 0 0
5	0	RADOŠEVIĆ Frane	GS	P1P2P3	0 0 0

KONAČNI POREDAK

Plasman	Hrvač	Ekipa
1	PALATINUŠ Ivan	SES
2	REBIĆ MATEJ	HER
3	KRISTIČEVIĆ Vito	SES
4	HABRKA Petar	LUDB
5	RADOŠEVIĆ Frane	GS



TABLICA ELIMINACIJE

Kvalifikacije za Božićni turnir 2016

DJE GR 42 kg

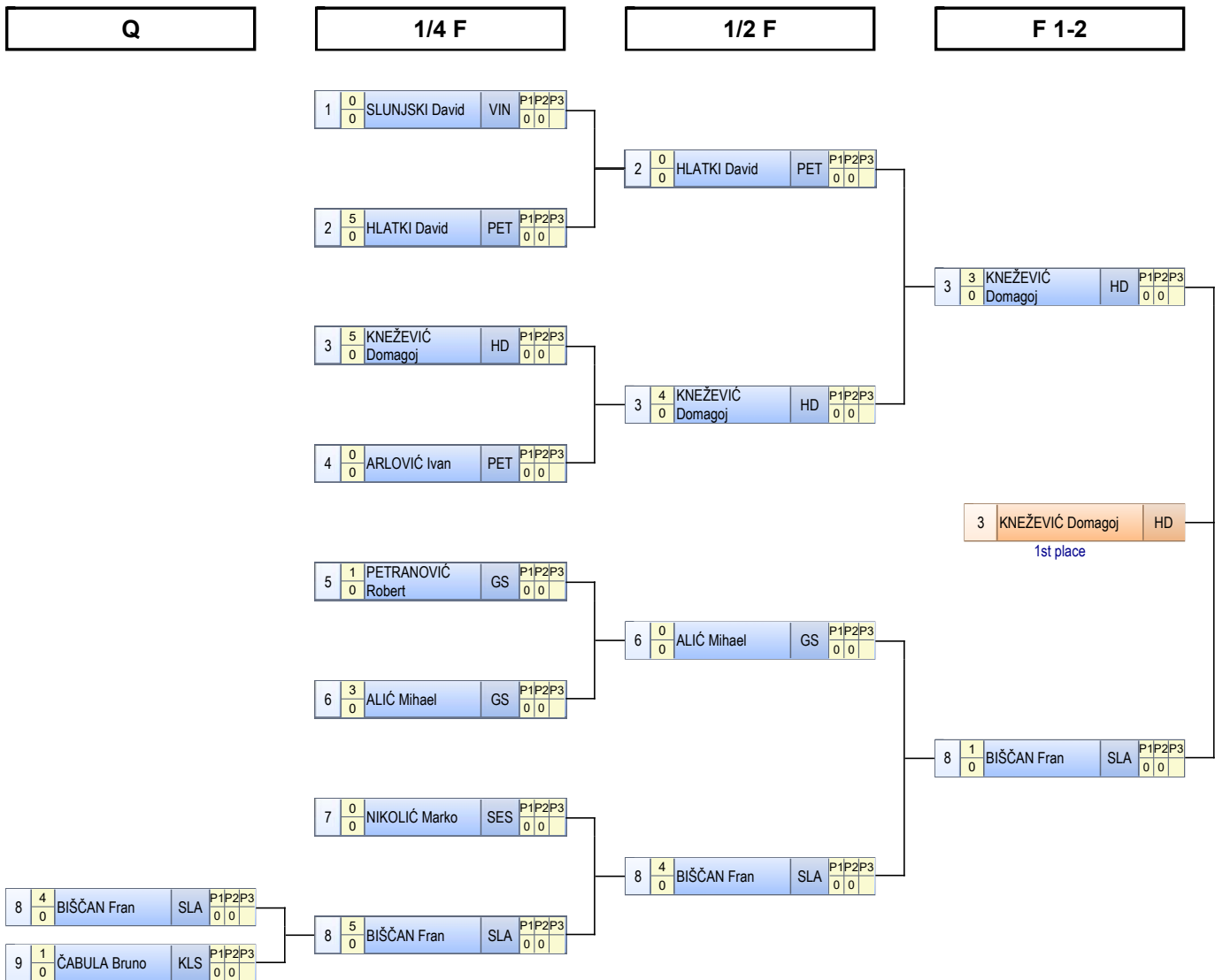

KONAČNI POREDAK

Repechage A



Repechage B

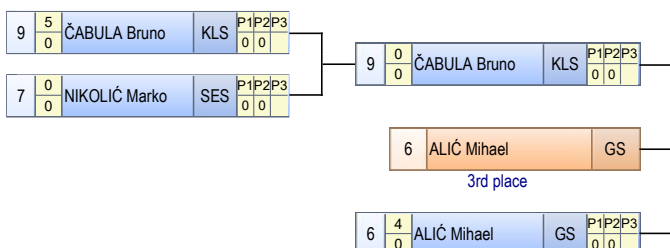

Plasman	Hrvač	Ekipa
1	KNEŽEVIĆ Domagoj	HD
2	BIŠČAN Fran	SLAT
3	ARLOVIĆ Ivan	PET
3	ALIĆ Mihael	GS
5	HLATKI David	PET
5	ČABULA Bruno	KLS
7	PETRANOVIĆ Robert	GS
8	SLUNJSKI David	VIND
8	NIKOLIĆ Marko	SES

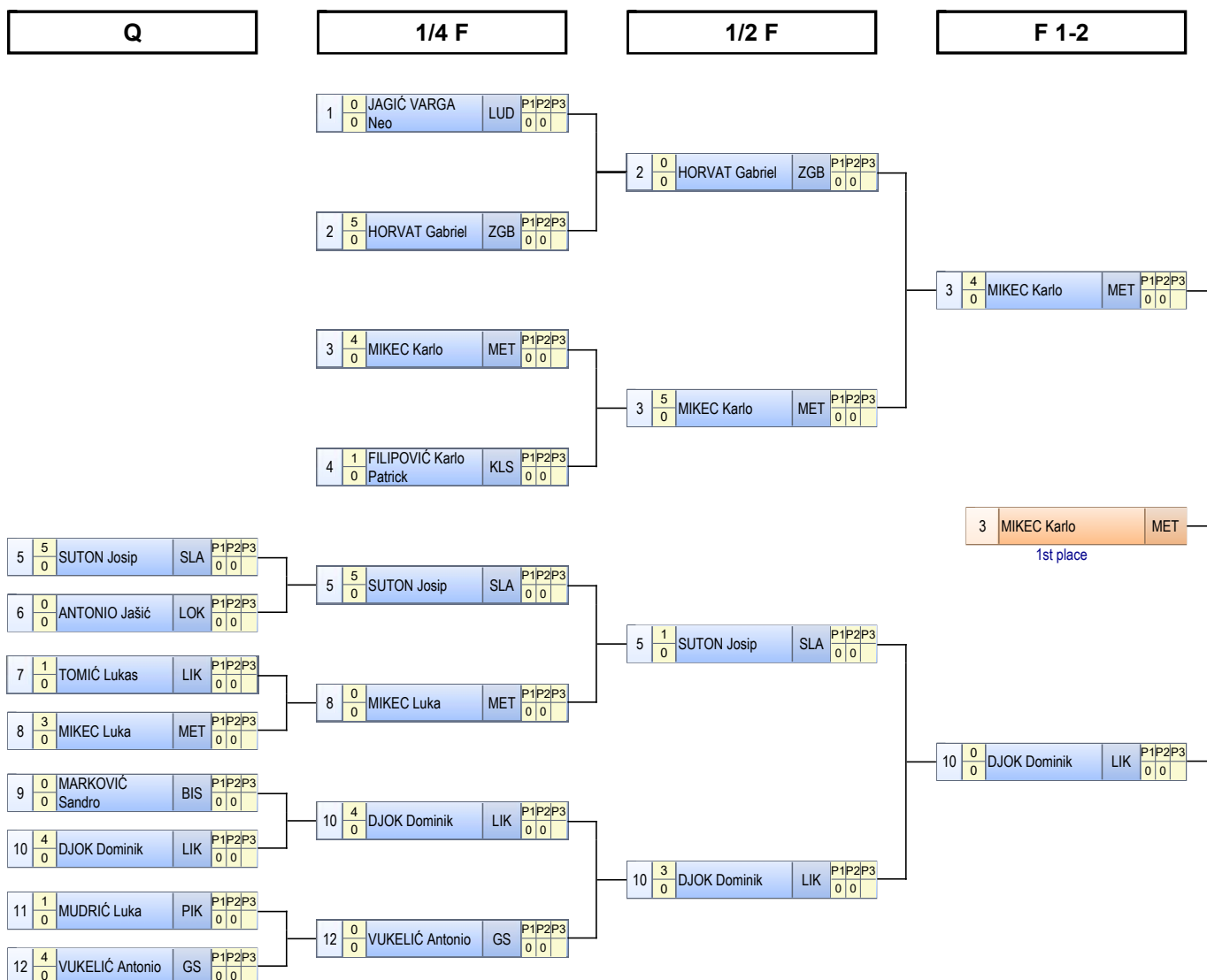

KONAČNI POREDAK

Plasman	Hrvač	Ekipa
1	MIKEC Karlo	MET
2	DJOK Dominik	LIKA
3	FILIPOVIĆ Karlo Patrick	KLS
3	SUTON Josip	SLAT
5	HORVAT Gabriel	ZGB
5	MARKOVIĆ Sandro	BIS
7	VUKELIĆ Antonio	GS
8	MIKEC Luka	MET
9	TOMIĆ Lukas	LIKA
9	MUDRIĆ Luka	PIKV
11	JAGIĆ VARGA Neo	LUDB
11	ANTONIO Jašić	LOK

Repechage A

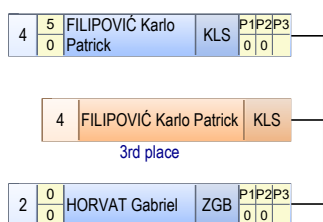

Repechage B

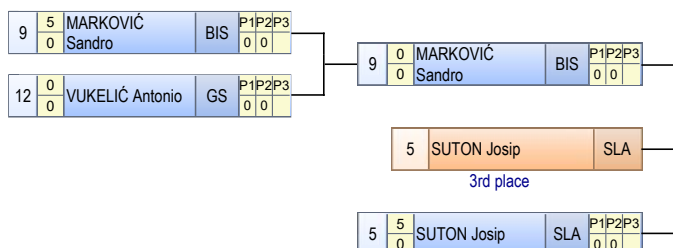

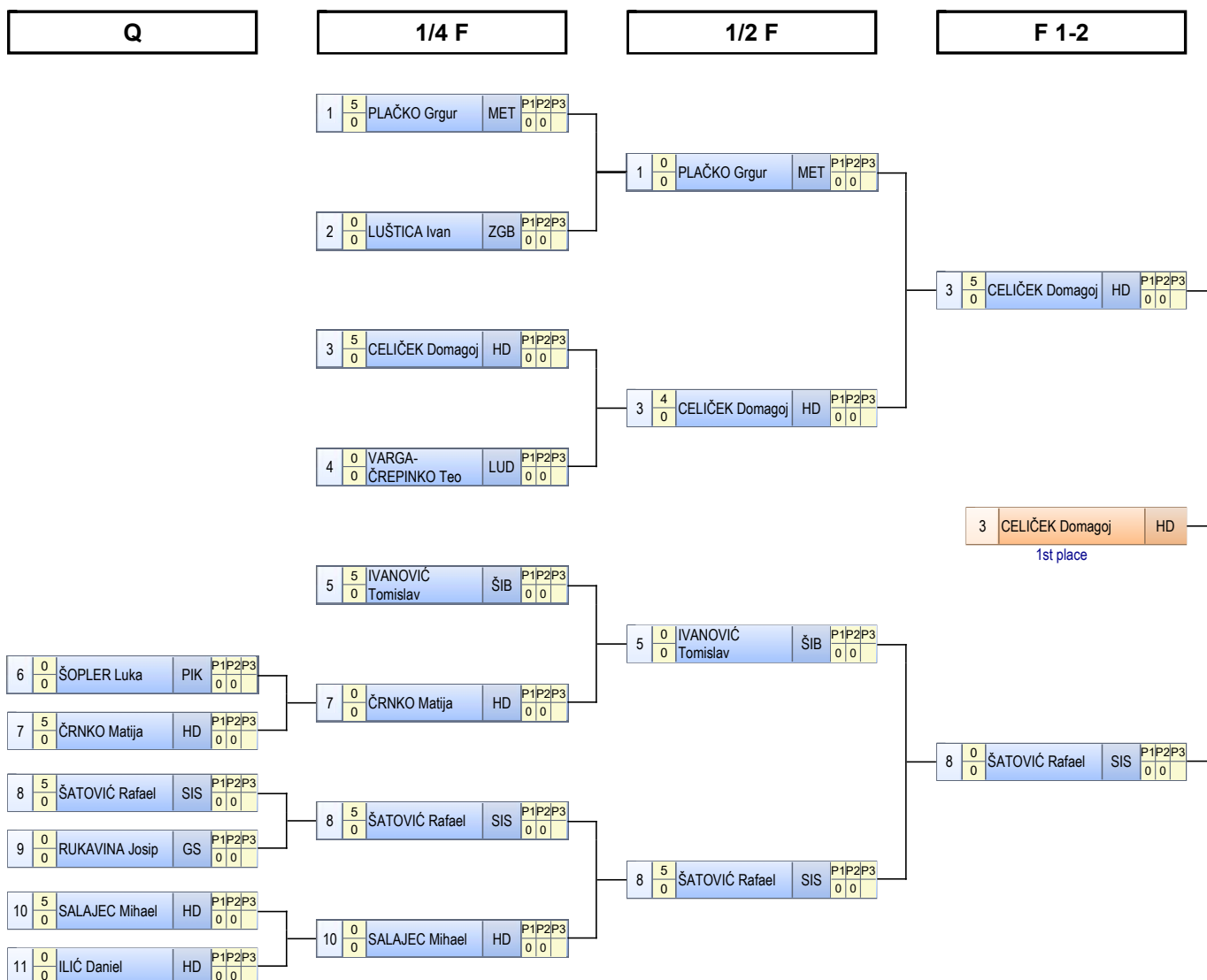

Repechage A



Repechage B

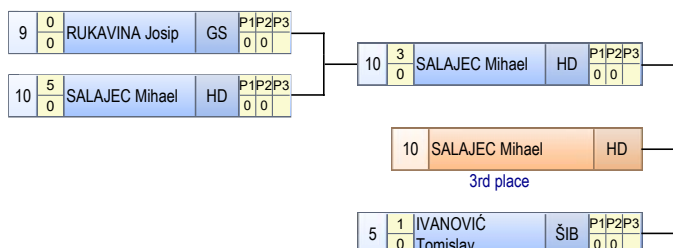

KONAČNI POREDAK

Plasman	Hrvač	Ekipa
1	CELIČEK Domagoj	HD
2	ŠATOVIĆ Rafael	SIS
3	VARGA-ČREPINKO Teo	LUDB
3	SALAJEC Mihael	HD
5	PLAČKO Grgur	MET
5	IVANOVIĆ Tomislav	ŠIB
7	ČRNKO Matija	HD
8	LUŠTICA Ivan	ZGB
8	ŠOPLER Luka	PIKV
8	RUKAVINA Josip	GS
8	ILIĆ Daniel	HD

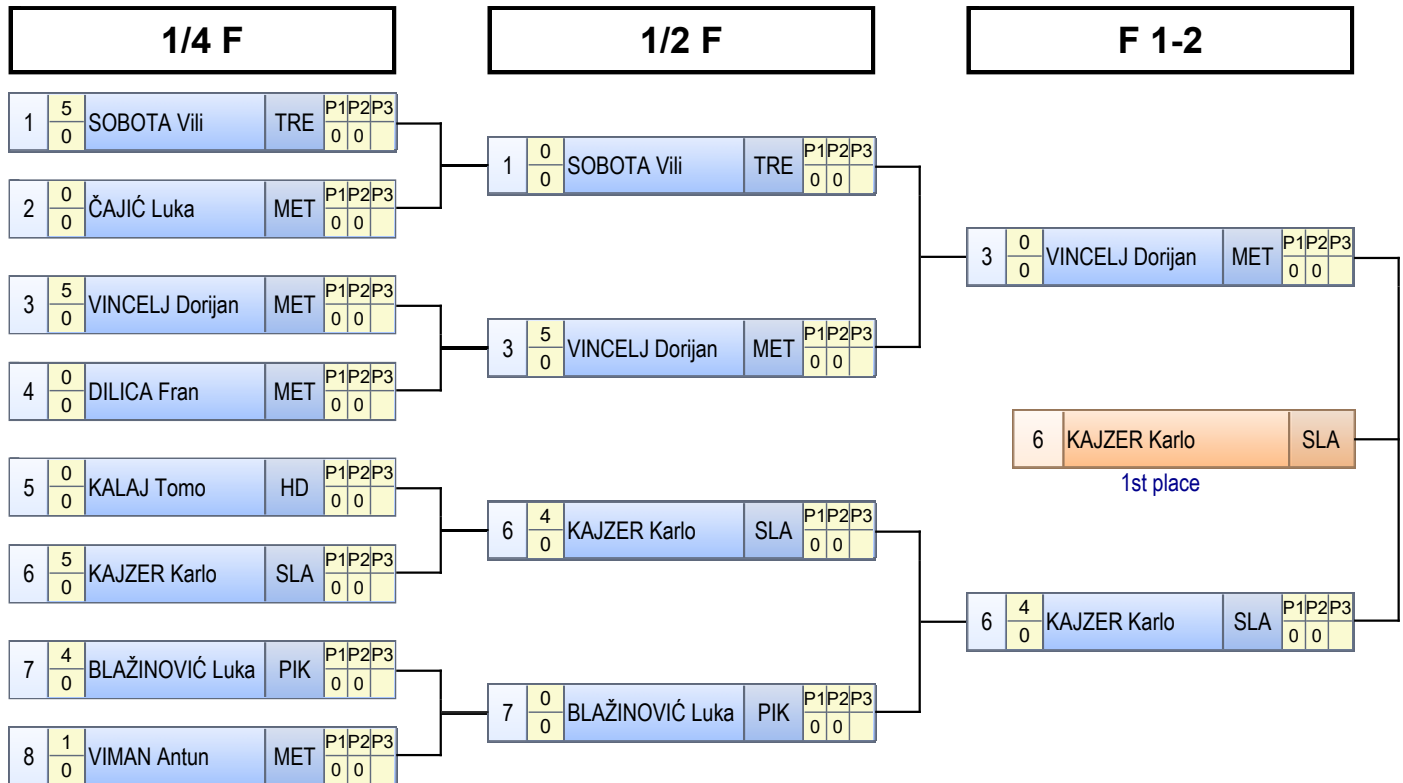

KONAČNI POREDAK

Plasman	Hrvač	Ekipa
1	KAJZER Karlo	SLAT
2	VINCELJ Dorijan	MET
3	SOBOTA Vili	TREŠ
3	KALAJ Tomo	HD
5	DILICA Fran	MET
5	BLAŽINOVIĆ Luka	PIKV
7	VIMAN Antun	MET
8	ČAJIĆ Luka	MET

Repechage A

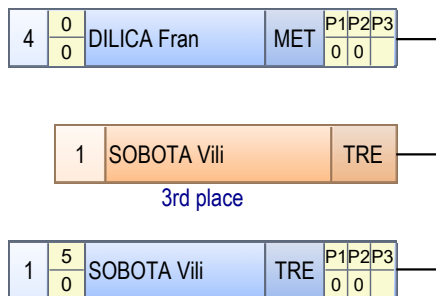

Repechage B

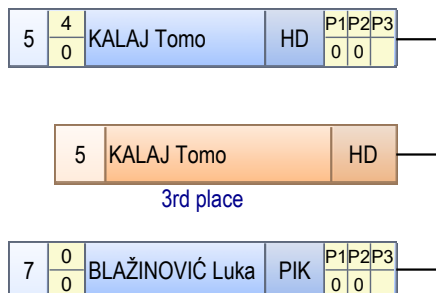

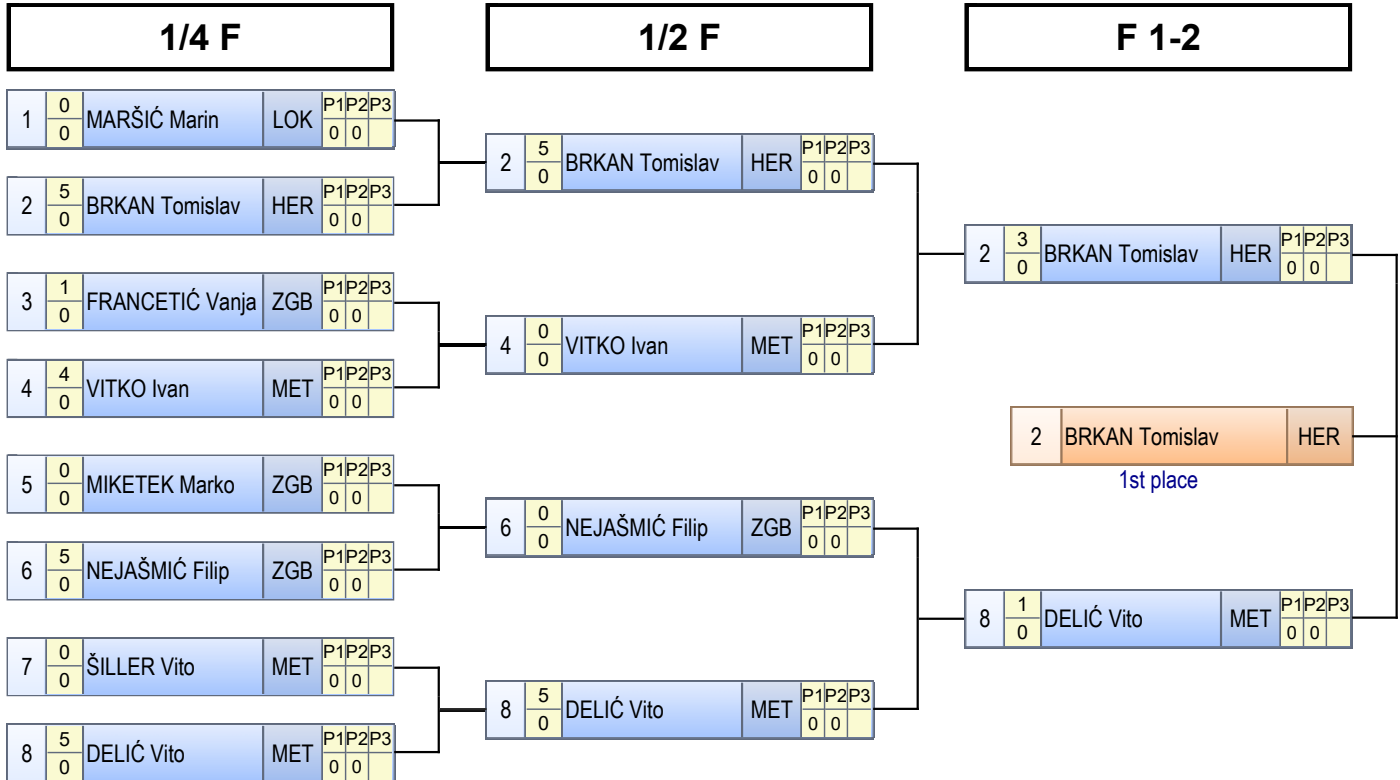

KONAČNI POREDAK

Plasman	Hrvač	Ekipa
1	BRKAN Tomislav	HER
2	DELIĆ Vito	MET
3	MARŠIĆ Marin	LOK
3	NEJAŠMIĆ Filip	ZGB
5	VITKO Ivan	MET
5	ŠILLER Vito	MET
7	FRANCETIĆ Vanja	ZGB
8	MIKETEK Marko	ZGB

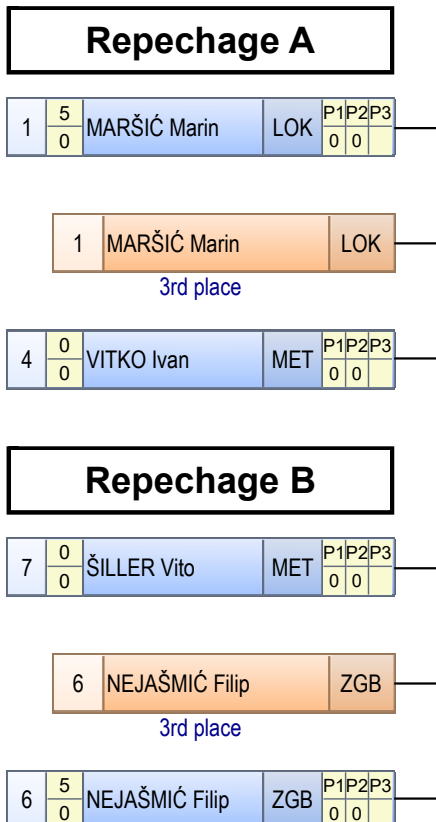

Q

1/2 F

F 1-2

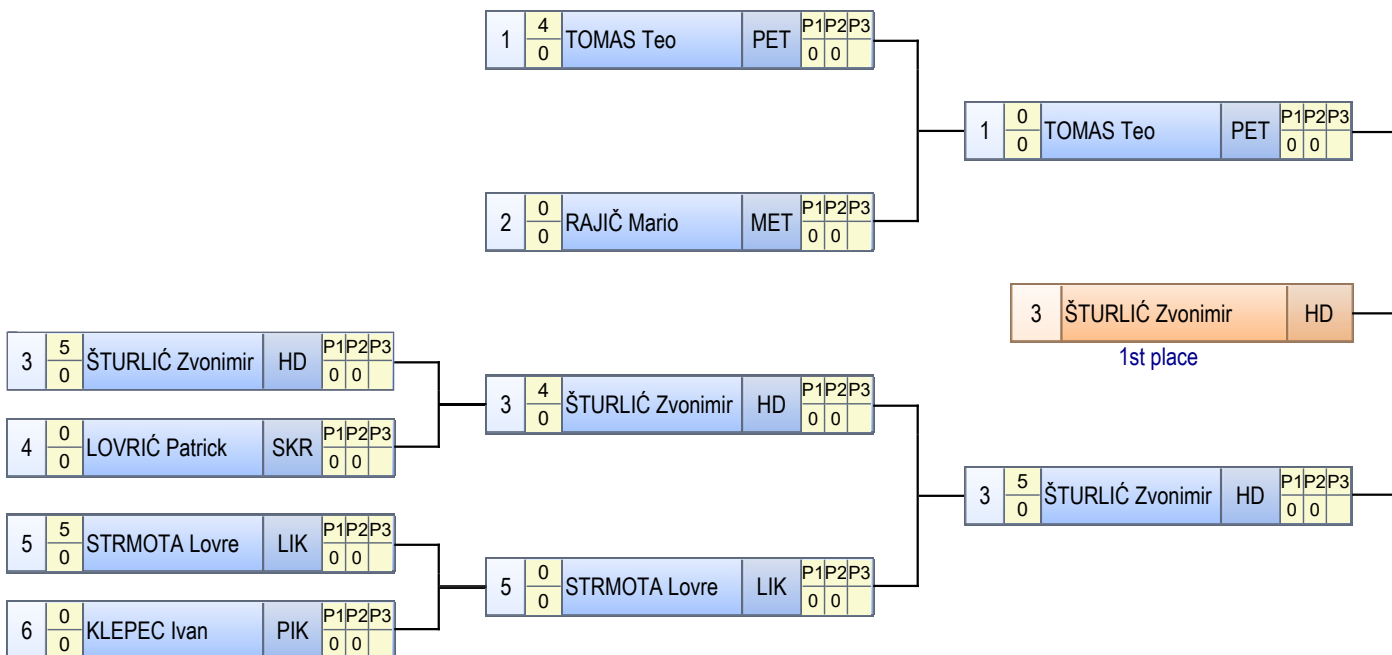

Repechage B

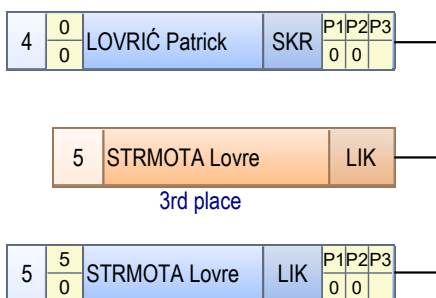

KONAČNI POREDAK

Plasman	Hrvač	Ekipa
1	ŠTURLIĆ Zvonimir	HD
2	TOMAS Teo	PET
3	RAJIČ Mario	MET
3	STRMOTA Lovre	LIKA
5	LOVRIĆ Patrick	SKR
6	KLEPEC Ivan	PIKV

R.br.	Hrvač	Ekipa	1	2	3	4	PP	PL.
1	HINEK-DELIĆ Robert	KLINČA SELA		0	4	0	4	3.
2	FALLER Roberto	SESVETSKI KRALJ	4		4	0	8	2.
3	MARAS Antonio	SESVETE	0	0		0	0	4.
4	ČANIĆ Lovro	HRVATSKI DRAGO	4	4	4		12	1.

N1

1	0 0	HINEK-DELIĆ Robert	KLS	P1 0	P2 0	P3 0
2	4 0	FALLER Roberto	SKR	P1 0	P2 0	P3 0

3	0 0	MARAS Antonio	SES	P1 0	P2 0	P3 0
4	4 0	ČANIĆ Lovro	HD	P1 0	P2 0	P3 0

N2

1	4 0	HINEK-DELIĆ Robert	KLS	P1 0	P2 0	P3 0
3	0 0	MARAS Antonio	SES	P1 0	P2 0	P3 0

2	0 0	FALLER Roberto	SKR	P1 0	P2 0	P3 0
4	4 0	ČANIĆ Lovro	HD	P1 0	P2 0	P3 0

N3

1	0 0	HINEK-DELIĆ Robert	KLS	P1 0	P2 0	P3 0
4	4 0	ČANIĆ Lovro	HD	P1 0	P2 0	P3 0

2	4 0	FALLER Roberto	SKR	P1 0	P2 0	P3 0
3	0 0	MARAS Antonio	SES	P1 0	P2 0	P3 0

KONAČNI POREDAK

Plasman	Hrvač	Ekipa
1	ČANIĆ Lovro	HD
2	FALLER Roberto	SKR
3	HINEK-DELIĆ Robert	KLS
4	MARAS Antonio	SES

32 kg			
1	BOŠNJAK Robert	ZAGREB	7.0
2	MIHALIC Matej	PIK VRBOVEC	5.0
			12.0
35 kg			
1	OSMANOVIĆ Renato	SESVETSKI KRALJEVEC	7.0
2	GARDILO Ivan	SLATINA	5.0
3	ČOSIĆ Tomislav	VINDIJA	3.5
			15.5
38 kg			
1	PALATINUŠ Ivan	SESVETE	7.0
2	REBIĆ MATEJ	HERKUL	5.0
3	KRISTIČEVIĆ Vito	SESVETE	3.5
4	HABRKA Petar	LUDBREG	3.5
5	RADOŠEVIĆ Frane	GOSPIĆ	
			19.0
42 kg			
1	KNEŽEVIĆ Domagoj	HRVATSKI DRAGOVOLJAC	7.0
2	BIŠČAN Fran	SLATINA	5.0
3	ARLOVIĆ Ivan	PETRINJA	3.5
3	ALIĆ Mihael	GOSPIĆ	3.5
5	HLATKI David	PETRINJA	
5	ČABULA Bruno	KLINČA SELA	
			19.0
47 kg			
1	MIKEC Karlo	METALAC	7.0
2	DJOK Dominik	LIKA	5.0
3	FILIPOVIĆ Karlo Patrick	KLINČA SELA	3.5
3	SUTON Josip	SLATINA	3.5
5	HORVAT Gabriel	ZAGREB	
5	MARKOVIĆ Sandro	BISTRA	
			19.0
53 kg			
1	CELIČEK Domagoj	HRVATSKI DRAGOVOLJAC	7.0
2	ŠATOVIĆ Rafael	SISAK	5.0
3	VARGA-ČREPINKO Teo	LUDBREG	3.5
3	SALAJEC Mihael	HRVATSKI DRAGOVOLJAC	3.5
5	PLAČKO Grgur	METALAC	
5	IVANOVIĆ Tomislav	ŠIBENIK	
			19.0
59 kg			
1	KAJZER Karlo	SLATINA	7.0
2	VINCELJ Dorijan	METALAC	5.0
3	SOBOTA Vili	TREŠNJEVKA	3.5
3	KALAJ Tomo	HRVATSKI DRAGOVOLJAC	3.5
5	DILICA Fran	METALAC	
5	BLAŽINOVIĆ Luka	PIK VRBOVEC	
			19.0
66 kg			
1	BRKAN Tomislav	HERKUL	7.0
2	DELIĆ Vito	METALAC	5.0
3	MARŠIĆ Marin	LOKOMOTIVA	3.5
3	NEJAŠMIĆ Filip	ZAGREB	3.5



POJEDINAČNI POREDAK PO KATEGORIJAMA

Kvalifikacije za Božićni turnir 2016

DJE GR



5	VITKO Ivan	METALAC	
5	ŠILLER Vito	METALAC	
			19.0

73 kg			
1	ŠTURLIĆ Zvonimir	HRVATSKI DRAGOVOLJAC	7.0
2	TOMAS Teo	PETRINJA	5.0
3	RAJIČ Mario	METALAC	3.5
3	STRMOTA Lovre	LIKA	3.5
5	LOVRIĆ Patrick	SESVETSKI KRALJEVEC	1.5
6	KLEPEC Ivan	PIK VRBOVEC	1.5
			22.0

85 kg			
1	ČANIĆ Lovro	HRVATSKI DRAGOVOLJAC	7.0
2	FALLER Roberto	SESVETSKI KRALJEVEC	5.0
3	HINEK-DELIĆ Robert	KLINČA SELA	3.5
4	MARAS Antonio	SESVETE	3.5
			19.0



EKIPNI PLASMAN

Kvalifikacije za Božićni turnir 2016

DJE GR



R.br.	EKIPA	MJESTO	32 kg	35 kg	38 kg	42 kg	47 kg	53 kg	59 kg	66 kg	73 kg	85 kg	Ukupno
1	HRVATSKI DRAGOVOLJAC	ZAGREB				7.0		10.5	3.5		7.0	7.0	35.0
2	METALAC	ZAGREB					7.0		5.0	5.0	3.5		20.5
3	SLATINA	SLATINA		5.0		5.0	3.5		7.0				20.5
4	SESVETE	ZAGREB			10.5							3.5	14.0
5	SESVETSKI KRALJEVEC	SESV. KRALJEVEC		7.0							1.5	5.0	13.5
6	HERKUL	ZAGREB			5.0					7.0			12.0
7	ZAGREB	ZAGREB	7.0							3.5			10.5
8	PETRINJA	PETRINJA				3.5					5.0		8.5
9	LIKA	ZAGREB					5.0				3.5		8.5
10	KLINČA SELA	KLINČA SELA					3.5					3.5	7.0
11	LUDBREG	LUDBREG			3.5			3.5					7.0
12	PIK VRBOVEC	VRBOVEC	5.0								1.5		6.5
13	SISAK	SISAK						5.0					5.0
14	GOSPIĆ	GOSPIĆ				3.5							3.5
15	VINDIJA	VARAŽDIN		3.5									3.5
16	LOKOMOTIVA	ZAGREB								3.5			3.5



EKIPNI PLASMAN

Kvalifikacije za Božićni turnir 2016

DJE GR



R.br.	EKIPA	MJESTO	32 kg	35 kg	38 kg	42 kg	47 kg	53 kg	59 kg	66 kg	73 kg	85 kg	Ukupno
16	TREŠNJEVKA	ZAGREB							3.5				3.5
18	BISTRA	BISTRA											0.0
18	ŠIBENIK	ŠIBENIK											0.0
UKUPNO			12	15.5	19	19	19	19	19	19	22	19	182.5



PREGLED SUDJELOVANJA

Kvalifikacije za Božićni turnir 2016

KAD GR



R.br.	EKIPA	MJESTO	42 kg	46 kg	50 kg	54 kg	58 kg	63 kg	69 kg	76 kg	85 kg	100 kg	Ukupno
1	BISTRA	BISTRA					1				1		2
2	FAMI	D. MIHOLJAC					1						1
3	GOSPIĆ	GOSPIĆ					1						1
4	HERKUL	ZAGREB					2		1			1	4
5	HRVATSKI DRAGOVOLJAC	ZAGREB	1				2						3
6	ISTARSKI BORAC	PULA				2		1	2				5
7	LIKA	ZAGREB			1			2	1				4
8	LUDBREG	LUDBREG						2	1				3
9	METALAC	ZAGREB	1	1			2	2	2	2	1	2	13
10	PETRINJA	PETRINJA					1	1	2		1	1	6
11	PIK VRBOVEC	VRBOVEC							2		1		3
12	PODRAVKA	KOPRIVNICA			1	1		1					3
13	SESVETE	ZAGREB		1		1		1	1			1	5
14	SESVETSKI KRALJEVEC	SESV. KRALJEVEC	1	1	1			2	2			1	8
15	SISAK	SISAK						1		1	1		3
16	SLATINA	SLATINA	1				1	2		1			5



PREGLED SUDJELOVANJA

Kvalifikacije za Božićni turnir 2016

KAD GR



R.br.	EKIPA	MJESTO	42 kg	46 kg	50 kg	54 kg	58 kg	63 kg	69 kg	76 kg	85 kg	100 kg	Ukupno
17	TREŠNJEVKA	ZAGREB							1				1
18	VINDIJA	VARAŽDIN	1					1	2	2	1		7
19	ZAGREB	ZAGREB		1			1		2		2	1	7
UKUPNO NATJECATELJA			5	4	3	4	12	16	19	6	8	7	84

R.br.	Hrvač	Ekipa	1	2	3	4	5	PP	PL.
1	JEMIĆ Dominik	HRVATSKI DRAGO		4	0	0	0	4	4.
2	BELAN Filip	METALAC	0		0	0	0	0	5.
3	MINAUF Antonio	SLATINA	4	4		3	4	15	1.
4	FAJFARIĆ Luka	VINDIJA	4	4	1		4	13	2.
5	ŽEGMAN Dominik	SESVETSKI KRALJ	4	4	0	1		9	3.

N1

1	4/0	JEMIĆ Dominik	HD	P1P2P3 0 0 0
2	0/0	BELAN Filip	MET	P1P2P3 0 0 0

3	3/0	MINAUF Antonio	SLA	P1P2P3 0 0 0
4	1/0	FAJFARIĆ Luka	VIN	P1P2P3 0 0 0

N2

5	4/0	ŽEGMAN Dominik	SKR	P1P2P3 0 0 0
1	0/0	JEMIĆ Dominik	HD	P1P2P3 0 0 0

2	0/0	BELAN Filip	MET	P1P2P3 0 0 0
3	4/0	MINAUF Antonio	SLA	P1P2P3 0 0 0

N3

4	4/0	FAJFARIĆ Luka	VIN	P1P2P3 0 0 0
1	0/0	JEMIĆ Dominik	HD	P1P2P3 0 0 0

5	4/0	ŽEGMAN Dominik	SKR	P1P2P3 0 0 0
2	0/0	BELAN Filip	MET	P1P2P3 0 0 0

N4

3	4/0	MINAUF Antonio	SLA	P1P2P3 0 0 0
1	0/0	JEMIĆ Dominik	HD	P1P2P3 0 0 0

4	4/0	FAJFARIĆ Luka	VIN	P1P2P3 0 0 0
5	1/0	ŽEGMAN Dominik	SKR	P1P2P3 0 0 0

N5

2	0/0	BELAN Filip	MET	P1P2P3 0 0 0
4	4/0	FAJFARIĆ Luka	VIN	P1P2P3 0 0 0

3	4/0	MINAUF Antonio	SLA	P1P2P3 0 0 0
5	0/0	ŽEGMAN Dominik	SKR	P1P2P3 0 0 0

KONAČNI POREDAK

Plasman	Hrvač	Ekipa
1	MINAUF Antonio	SLAT
2	FAJFARIĆ Luka	VIND
3	ŽEGMAN Dominik	SKR
4	JEMIĆ Dominik	HD
5	BELAN Filip	MET

R.br.	Hrvač	Ekipa	1	2	3	4	PP	PL.
1	IVIĆ Juraj	SESVETSKI KRALJ		4	4	4	12	1.
2	ZURAK Lovro	METALAC	0		0	4	4	3.
3	HADER Josip	ZAGREB	0	4		3	7	2.
4	ĐAPIĆ Matej	SESVETE	0	0	1		1	4.

N1

1	$\frac{4}{0}$	IVIĆ Juraj	SKR	$\frac{P1}{0}$	$\frac{P2}{0}$	$\frac{P3}{0}$
2	$\frac{0}{0}$	ZURAK Lovro	MET	$\frac{P1}{0}$	$\frac{P2}{0}$	$\frac{P3}{0}$

3	$\frac{3}{0}$	HADER Josip	ZGB	$\frac{P1}{0}$	$\frac{P2}{0}$	$\frac{P3}{0}$
4	$\frac{1}{0}$	ĐAPIĆ Matej	SES	$\frac{P1}{0}$	$\frac{P2}{0}$	$\frac{P3}{0}$

N2

1	$\frac{4}{0}$	IVIĆ Juraj	SKR	$\frac{P1}{0}$	$\frac{P2}{0}$	$\frac{P3}{0}$
3	$\frac{0}{0}$	HADER Josip	ZGB	$\frac{P1}{0}$	$\frac{P2}{0}$	$\frac{P3}{0}$

2	$\frac{4}{0}$	ZURAK Lovro	MET	$\frac{P1}{0}$	$\frac{P2}{0}$	$\frac{P3}{0}$
4	$\frac{0}{0}$	ĐAPIĆ Matej	SES	$\frac{P1}{0}$	$\frac{P2}{0}$	$\frac{P3}{0}$

N3

1	$\frac{4}{0}$	IVIĆ Juraj	SKR	$\frac{P1}{0}$	$\frac{P2}{0}$	$\frac{P3}{0}$
4	$\frac{0}{0}$	ĐAPIĆ Matej	SES	$\frac{P1}{0}$	$\frac{P2}{0}$	$\frac{P3}{0}$

2	$\frac{0}{0}$	ZURAK Lovro	MET	$\frac{P1}{0}$	$\frac{P2}{0}$	$\frac{P3}{0}$
3	$\frac{4}{0}$	HADER Josip	ZGB	$\frac{P1}{0}$	$\frac{P2}{0}$	$\frac{P3}{0}$

KONAČNI POREDAK

Plasman	Hrvač	Ekipa
1	IVIĆ Juraj	SKR
2	HADER Josip	ZGB
3	ZURAK Lovro	MET
4	ĐAPIĆ Matej	SES

R.br.	Hrvač	Ekipa	1	2	3	PP	PL.
1	VERČEVIĆ Filip	PODRAVKA		5	4	9	1.
2	ĐURIĆ Tomislav	LIKA	0		4	4	2.
3	ŠIMUNKOVIĆ Nikola	SESVETSKI KRALJ	0	0		0	3.

N1						
1	5 0	VERČEVIĆ Filip	POD	P1 0	P2 0	P3 0
2	0 0	ĐURIĆ Tomislav	LIK	P1 0	P2 0	P3 0

N2						
3	0 0	ŠIMUNKOVIĆ Nikola	SKR	P1 0	P2 0	P3 0
1	4 0	VERČEVIĆ Filip	POD	P1 0	P2 0	P3 0

N3						
2	4 0	ĐURIĆ Tomislav	LIK	P1 0	P2 0	P3 0
3	0 0	ŠIMUNKOVIĆ Nikola	SKR	P1 0	P2 0	P3 0

KONAČNI POREDAK

Plasman	Hrvač	Ekipa
1	VERČEVIĆ Filip	PODR
2	ĐURIĆ Tomislav	LIKA
3	ŠIMUNKOVIĆ Nikola	SKR

R.br.	Hrvač	Ekipa	1	2	3	4	PP	PL.
1	BOŠKOVIĆ Erik	ISTARSKI BORAC		0	0	0	0	4.
2	IVANČIĆ Matej	SESVETE	4		4	0	8	2.
3	MATIĆ Florijan	ISTARSKI BORAC	4	1		0	5	3.
4	PICER Filip	PODRAVKA	4	4	4		12	1.

N1

1	0 0	BOŠKOVIĆ Erik	IB	P1 0	P2 0	P3 0
2	4 0	IVANČIĆ Matej	SES	P1 0	P2 0	P3 0

3	0 0	MATIĆ Florijan	IB	P1 0	P2 0	P3 0
4	4 0	PICER Filip	POD	P1 0	P2 0	P3 0

N2

1	0 0	BOŠKOVIĆ Erik	IB	P1 0	P2 0	P3 0
3	4 0	MATIĆ Florijan	IB	P1 0	P2 0	P3 0

2	0 0	IVANČIĆ Matej	SES	P1 0	P2 0	P3 0
4	4 0	PICER Filip	POD	P1 0	P2 0	P3 0

N3

1	0 0	BOŠKOVIĆ Erik	IB	P1 0	P2 0	P3 0
4	4 0	PICER Filip	POD	P1 0	P2 0	P3 0

2	4 0	IVANČIĆ Matej	SES	P1 0	P2 0	P3 0
3	1 0	MATIĆ Florijan	IB	P1 0	P2 0	P3 0

KONAČNI POREDAK

Plasman	Hrvač	Ekipa
1	PICER Filip	PODR
2	IVANČIĆ Matej	SES
3	MATIĆ Florijan	IB
4	BOŠKOVIĆ Erik	IB

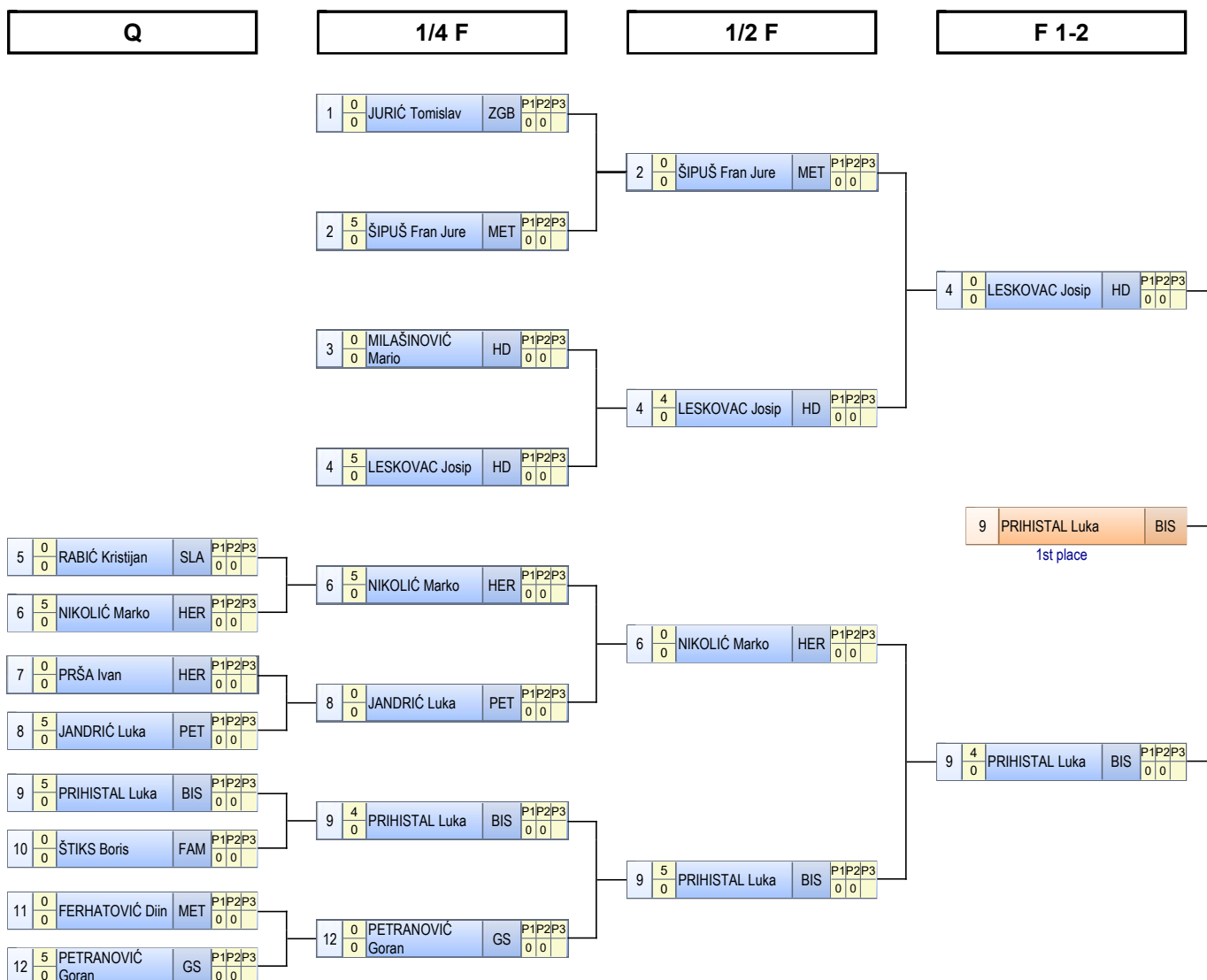

9 PRIHISTAL Luka BIS
1st place

9 PRIHISTAL Luka BIS
P1P2P3
0 0

KONAČNI POREDAK

Plasman	Hrvač	Ekipa
1	PRIHISTAL Luka	BIS
2	LESKOVAC Josip	HD
3	ŠIPUŠ Fran Jure	MET
3	NIKOLIĆ Marko	HER
5	MILAŠINOVIĆ Mario	HD
5	PETRANOVIĆ Goran	GS
7	JANDRIĆ Luka	PET
8	ŠTIKS Boris	FAMI
9	JURIĆ Tomislav	ZGB
9	RABIĆ Kristijan	SLAT
9	PRŠA Ivan	HER
9	FERHATOVIĆ Diin	MET

Repechage A

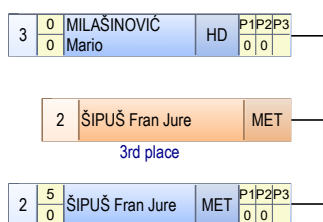

Repechage B

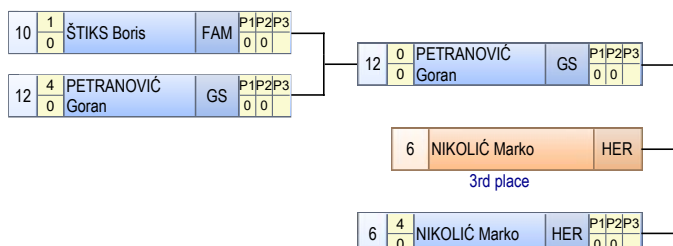

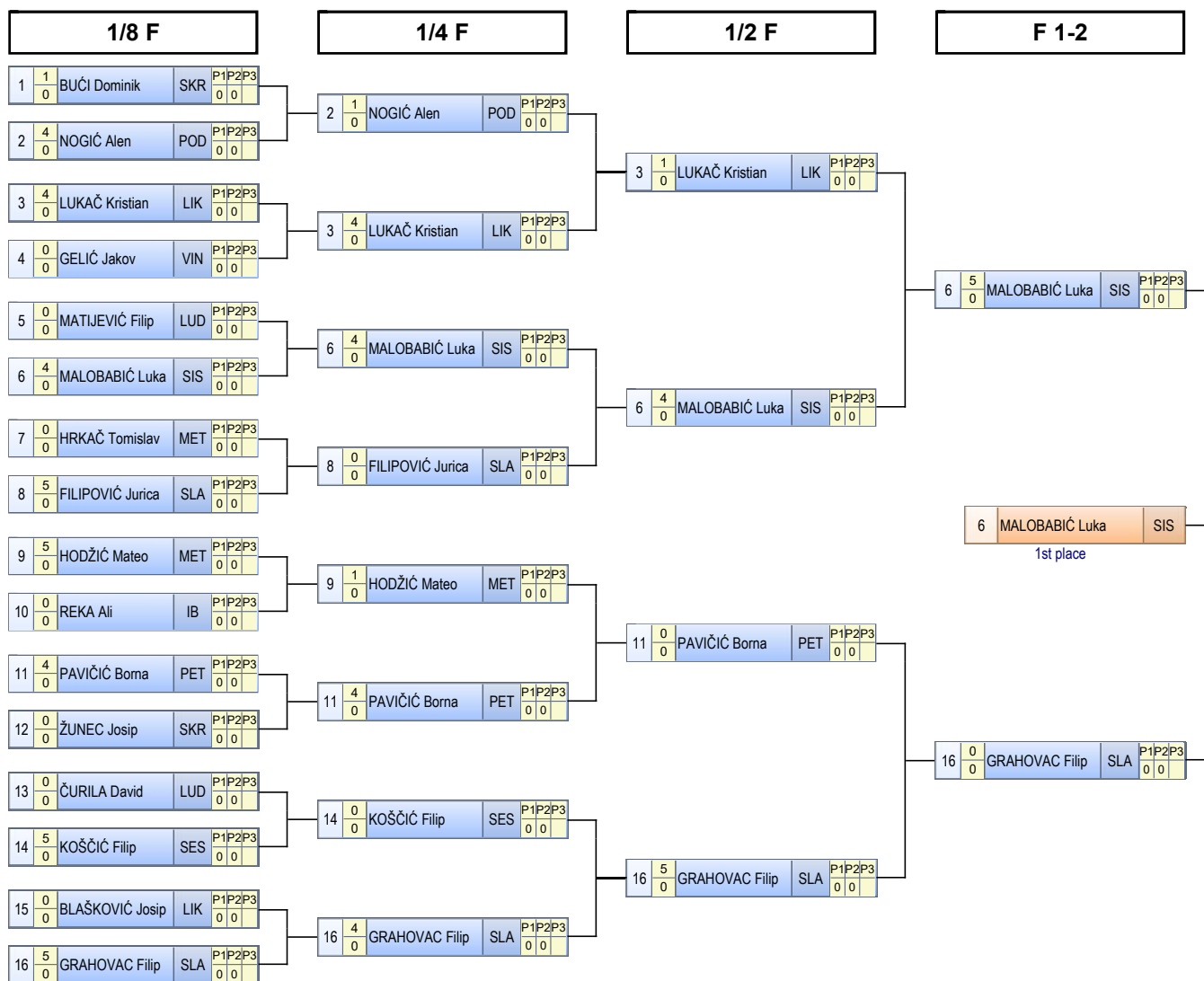

KONAČNI POREDAK

Plasman	Hrvač	Ekipa
1	MALOBABIĆ Luka	SIS
2	GRAHOVAC Filip	SLAT
3	LUKAČ Kristian	LIKA
3	KOŠČIĆ Filip	SES
5	FILIPOVIĆ Jurica	SLAT
5	PAVIČIĆ Borna	PET
7	HODŽIĆ Mateo	MET
8	NOGIĆ Alen	PODR
9	BUČI Dominik	SKR
10	GELIĆ Jakov	VIND
10	MATIJEVIĆ Filip	LUDB
10	HRKAČ Tomislav	MET
10	REKA Ali	IB
10	ŽUNEC Josip	SKR
10	ČURILA David	LUDB
10	BLAŠKOVIĆ Josip	LIKA

Repechage A

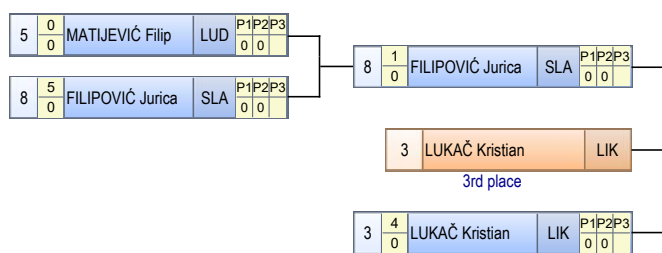

Repechage B

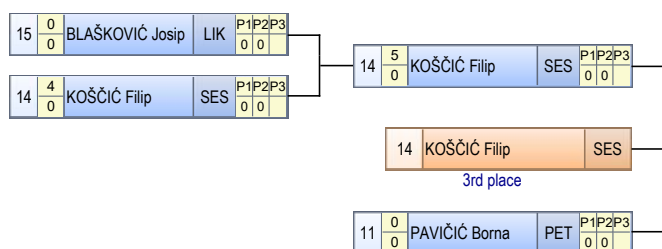



TABLICA ELIMINACIJE

Kvalifikacije za Božićni turnir 2016

KAD GR 69 kg

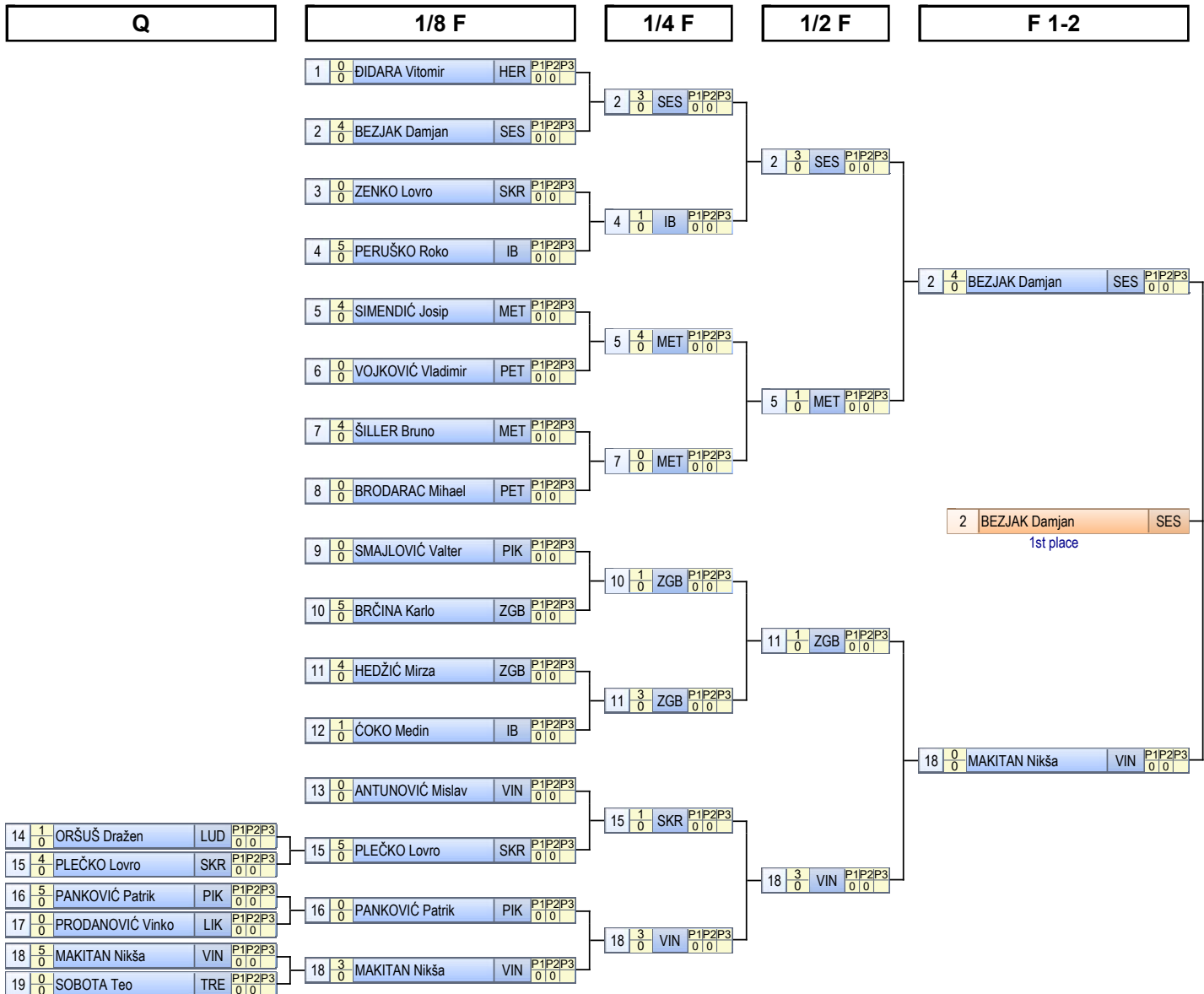

KONAČNI POREDAK

Plasman	Hrvač	Ekipa
1	BEZJAK Damjan	SES
2	MAKITAN Nikša	VIND
3	SIMENDIĆ Josip	MET
3	PLEČKO Lovro	SKR
5	PERUŠKO Roko	IB
5	HEDŽIĆ Mirza	ZGB
7	PANKOVIĆ Patrik	PIKV
8	BRČINA Karlo	ZGB
9	ŠILLER Bruno	MET
10	ČOKO Medin	IB
10	ORŠUŠ Dražen	LUDB
12	ĐIDARA Vitimir	HER
12	ZENKO Lovro	SKR
12	VOJKOVIĆ Vladimir	PET
12	BRODARAC Mihael	PET
12	SMAJLOVIĆ Valter	PIKV
12	ANTUNOVIĆ Mislav	VIND
12	PRODANOVIĆ Vinko	LIKA
12	SOBOTA Teo	TREŠ

Repechage A

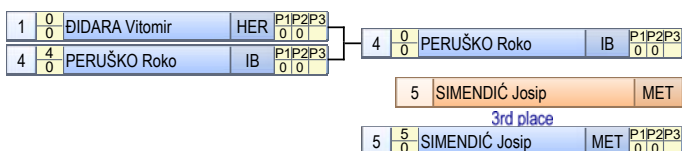

Repechage B

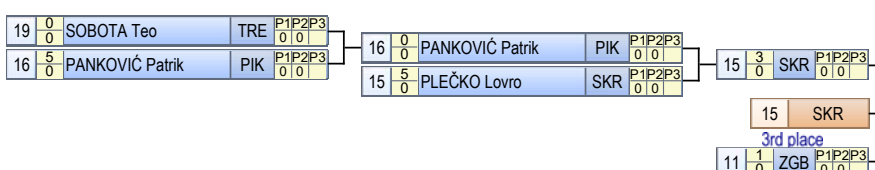

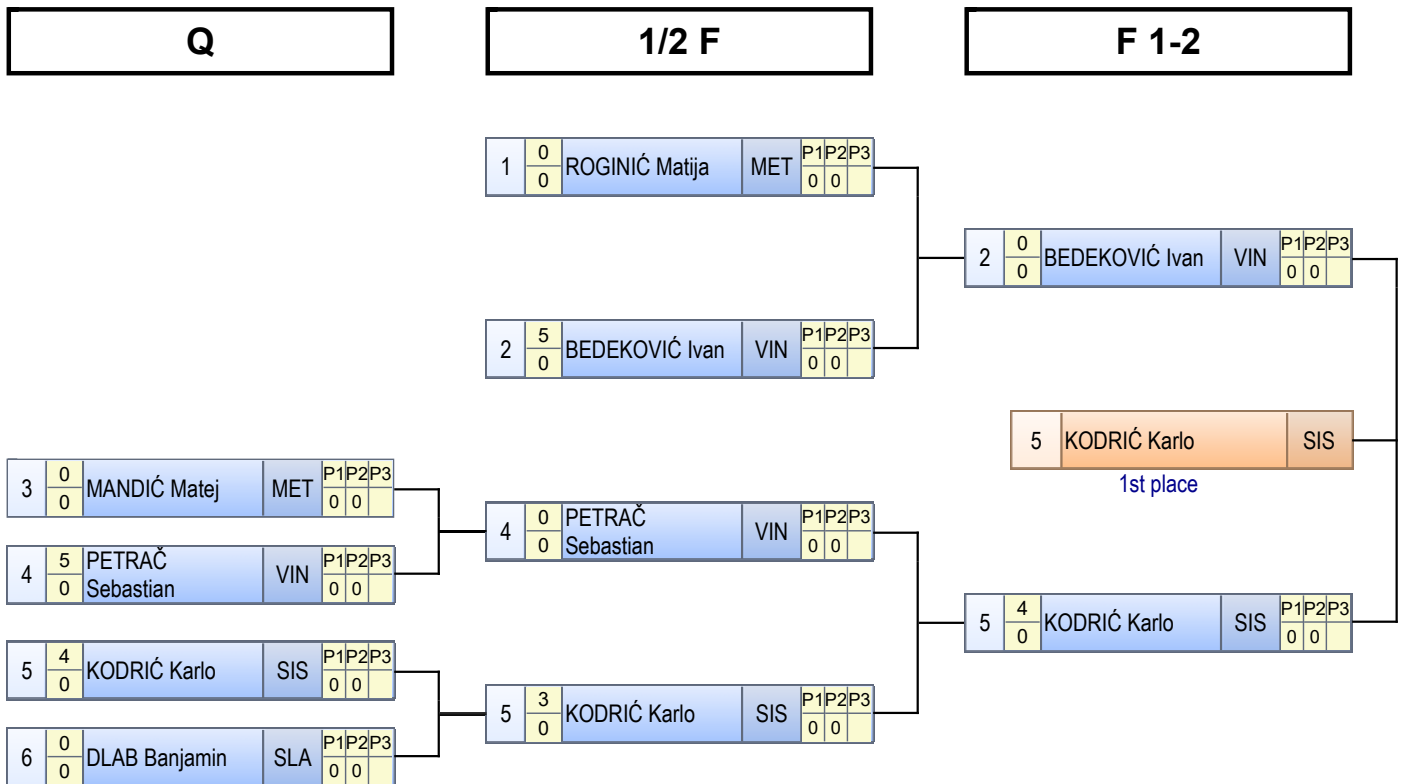

KONAČNI POREDAK

Plasman	Hrvač	Ekipa
1	KODRIĆ Karlo	SIS
2	BEDEKOVIĆ Ivan	VIND
3	ROGINIĆ Matija	MET
3	PETRAČ Sebastian	VIND
5	DLAB Benjamin	SLAT
6	MANDIĆ Matej	MET

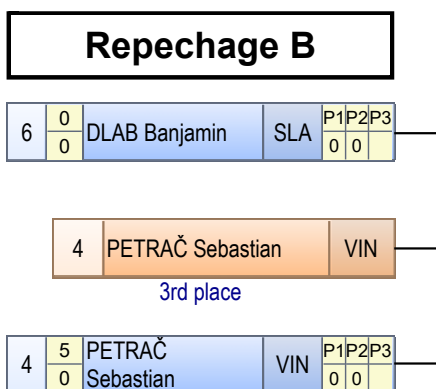

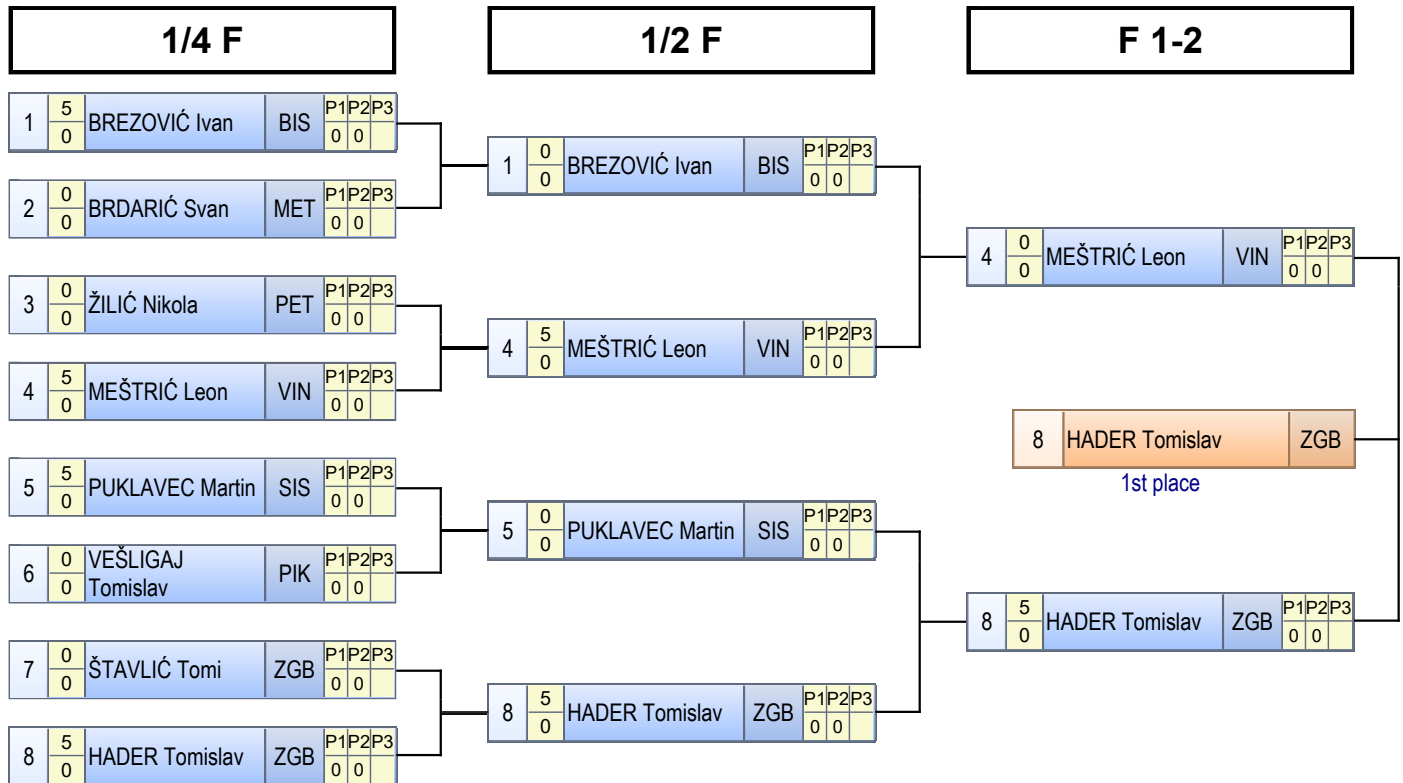

KONAČNI POREDAK

Plasman	Hrvač	Ekipa
1	HADER Tomislav	ZGB
2	MEŠTRIĆ Leon	VIND
3	BREZOVIĆ Ivan	BIS
3	ŠTAVLIĆ Tomi	ZGB
5	ŽILIĆ Nikola	PET
5	PUKLAVEC Martin	SIS
7	BRDARIĆ Svan	MET
7	VEŠLIGAJ Tomislav	PIKV

Repechage A



Repechage B

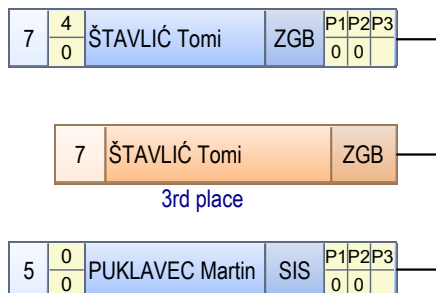

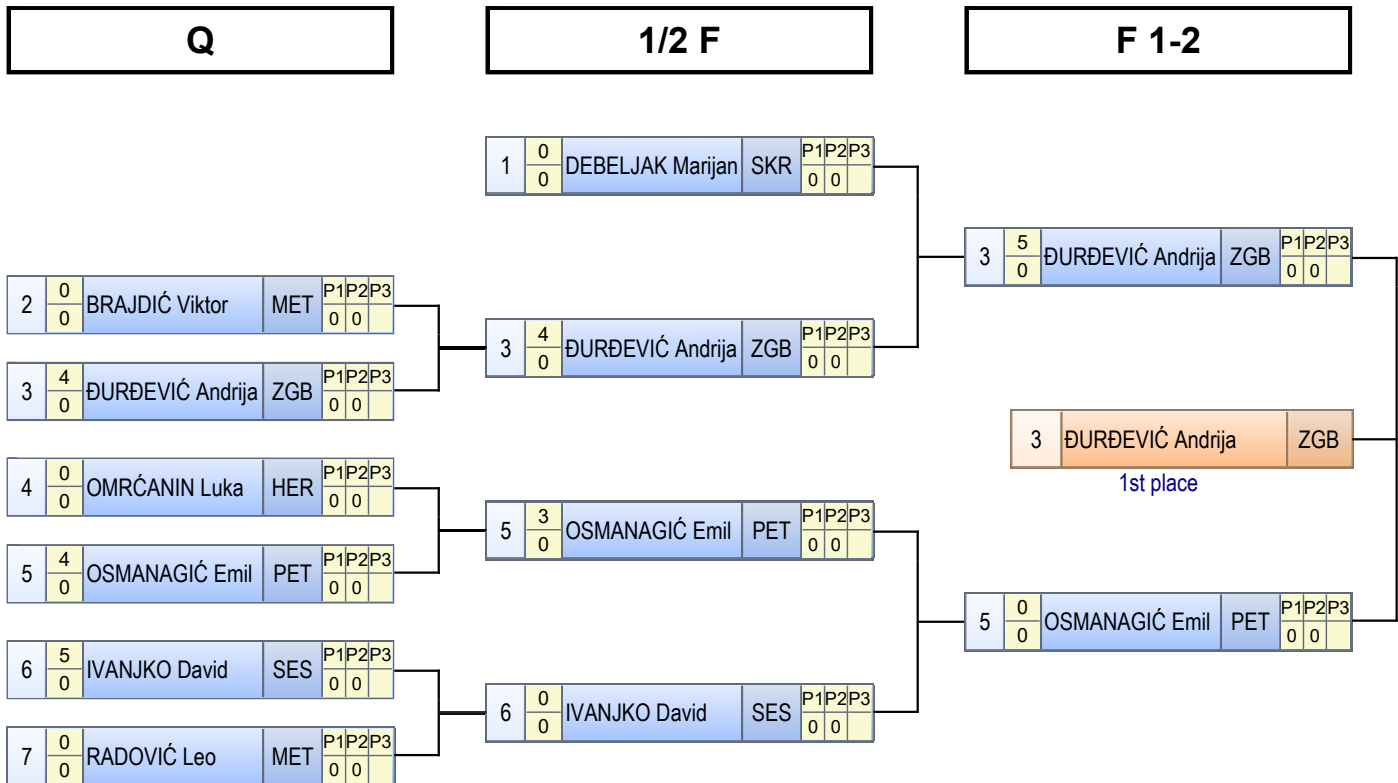

KONAČNI POREDAK

Repechage A

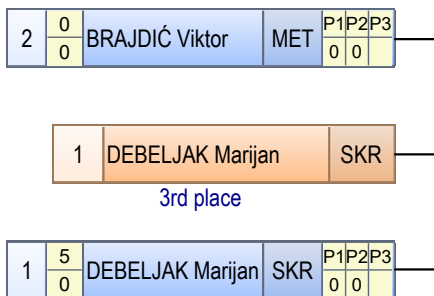

Repechage B

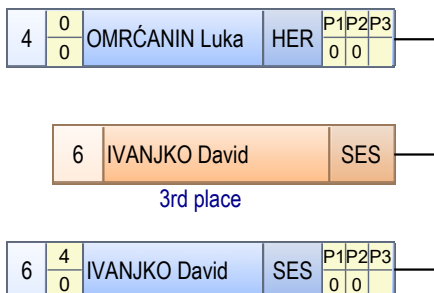

Plasman	Hrvač	Ekipa
1	ĐURĐEVIĆ Andrija	ZGB
2	OSMANAGIĆ Emil	PET
3	DEBELJAK Marijan	SKR
3	IVANJKO David	SES
5	BRAJDIĆ Viktor	MET
5	OMRČANIN Luka	HER
7	RADOVIĆ Leo	MET

42 kg			
1	MINAUF Antonio	SLATINA	7.0
2	FAJFARIĆ Luka	VINDIJA	5.0
3	ŽEGMAN Dominik	SESVETSKI KRALJEVEC	3.5
4	JEMIĆ Dominik	HRVATSKI DRAGOVOLJAC	3.5
5	BELAN Filip	METALAC	
			19.0

46 kg			
1	IVIĆ Juraj	SESVETSKI KRALJEVEC	7.0
2	HADER Josip	ZAGREB	5.0
3	ZURAK Lovro	METALAC	3.5
4	ĐAPIĆ Matej	SESVETE	3.5
			19.0

50 kg			
1	VERČEVIĆ Filip	PODRAVKA	7.0
2	ĐURIĆ Tomislav	LIKA	5.0
3	ŠIMUNKOVIĆ Nikola	SESVETSKI KRALJEVEC	3.5
			15.5

54 kg			
1	PICER Filip	PODRAVKA	7.0
2	IVANČIĆ Matej	SESVETE	5.0
3	MATIĆ Florijan	ISTARSKI BORAC	3.5
4	BOŠKOVIĆ Erik	ISTARSKI BORAC	3.5
			19.0

58 kg			
1	PRIHISTAL Luka	BISTRA	7.0
2	LESKOVAC Josip	HRVATSKI DRAGOVOLJAC	5.0
3	ŠIPUŠ Fran Jure	METALAC	3.5
3	NIKOLIĆ Marko	HERKUL	3.5
5	MILAŠINOVIĆ Mario	HRVATSKI DRAGOVOLJAC	
5	PETRANOVIĆ Goran	GOSPIĆ	
			19.0

63 kg			
1	MALOBABIĆ Luka	SISAK	7.0
2	GRAHOVAC Filip	SLATINA	5.0
3	LUKAČ Kristian	LIKA	3.5
3	KOŠČIĆ Filip	SESVETE	3.5
5	FILIPOVIĆ Jurica	SLATINA	
5	PAVIČIĆ Borna	PETRINJA	
			19.0

69 kg			
1	BEZJAK Damjan	SESVETE	7.0
2	MAKITAN Nikša	VINDIJA	5.0
3	SIMENDIĆ Josip	METALAC	3.5
3	PLEČKO Lovro	SESVETSKI KRALJEVEC	3.5
5	PERUŠKO Roko	ISTARSKI BORAC	
5	HEDŽIĆ Mirza	ZAGREB	
			19.0

76 kg			
1	KODRIĆ Karlo	SISAK	7.0
2	BEDEKOVIĆ Ivan	VINDIJA	5.0
3	ROGINIĆ Matija	METALAC	3.5
3	PETRAČ Sebastian	VINDIJA	3.5



POJEDINAČNI POREDAK PO KATEGORIJAMA

Kvalifikacije za Božićni turnir 2016

KAD GR



5	DLAB Benjamin	SLATINA	
6	MANDIĆ Matej	METALAC	
			19.0

85 kg			
1	HADER Tomislav	ZAGREB	7.0
2	MEŠTRIĆ Leon	VINDIJA	5.0
3	BREZOVIĆ Ivan	BISTRA	3.5
3	ŠTAVLIĆ Tomi	ZAGREB	3.5
5	ŽILIĆ Nikola	PETRINJA	
5	PUKLAVEC Martin	SISAK	
			19.0

100 kg			
1	ĐURĐEVIĆ Andrija	ZAGREB	7.0
2	OSMANAGIĆ Emil	PETRINJA	5.0
3	DEBELJAK Marijan	SESVETSKI KRALJEVEC	3.5
3	IVANJKO David	SESVETE	3.5
5	BRAJDIĆ Viktor	METALAC	
5	OMRČANIN Luka	HERKUL	
			19.0



EKIPNI PLASMAN

Kvalifikacije za Božićni turnir 2016

KAD GR



R.br.	EKIPA	MJESTO	42 kg	46 kg	50 kg	54 kg	58 kg	63 kg	69 kg	76 kg	85 kg	100 kg	Ukupno
1	VINDIJA	VARAŽDIN	5.0						5.0	8.5	5.0		23.5
2	ZAGREB	ZAGREB		5.0							10.5	7.0	22.5
3	SESVETE	ZAGREB		3.5		5.0		3.5	7.0			3.5	22.5
4	SESVETSKI KRALJEVEC	SESV. KRALJEVEC	3.5	7.0	3.5				3.5			3.5	21.0
5	SISAK	SISAK						7.0		7.0			14.0
6	PODRAVKA	KOPRIVNICA			7.0	7.0							14.0
7	METALAC	ZAGREB		3.5			3.5		3.5	3.5			14.0
8	SLATINA	SLATINA	7.0					5.0					12.0
9	BISTRA	BISTRA					7.0				3.5		10.5
10	HRVATSKI DRAGOVOLJAC	ZAGREB	3.5				5.0						8.5
11	LIKA	ZAGREB			5.0			3.5					8.5
12	ISTARSKI BORAC	PULA				7.0							7.0
13	PETRINJA	PETRINJA										5.0	5.0
14	HERKUL	ZAGREB					3.5						3.5
15	GOSPIĆ	GOSPIĆ											0.0
16	PIK VRBOVEC	VRBOVEC											0.0



EKIPNI PLASMAN

Kvalifikacije za Božićni turnir 2016

KAD GR



R.br.	EKIPA	MJESTO	42 kg	46 kg	50 kg	54 kg	58 kg	63 kg	69 kg	76 kg	85 kg	100 kg	Ukupno
17	FAMI	D. MIHOLJAC											0.0
18	LUDBREG	LUDBREG											0.0
19	TREŠNJEVKA	ZAGREB											0.0
UKUPNO			19	19	15.5	19	19	19	19	19	19	19	186.5