

**BOSNIA AND HERZEGOVINA (BIH)****Wrestler / Lutteur**

59 kg ALIBALIĆ, Ivano

CZECH REPUBLIC (CZE)**Wrestler / Lutteur**

73 kg POHLODEK, Daniel

GOSPIĆ (GS)**Wrestler / Lutteur**

53 kg RUPČIĆ, Antonijo

GREECE (GRE)**Wrestler / Lutteur**

38 kg KONSTANTINIDIS, Sokratis
42 kg YFANTIS, Achilleas
42 kg STASINOPOULOS, Panagiotis
42 kg KOLITSOPOULOS, Arionas
47 kg LYKOPOULOS, Vassileios
53 kg ATHANASIOU, Georgios
59 kg PAPPAS, Eleftherios
59 kg VOULGARIS, Menelaos
66 kg PAPPAS, Dimitrios

HRVATSKI DRAGOVOLJAC (HD)**Wrestler / Lutteur**

66 kg GRGIĆ, Dominik
73 kg RADIČEVIĆ, Antonio

HUNGARY (HUN)**Wrestler / Lutteur**

38 kg VEGH, Mate
38 kg CZUCZOR, Dominik
47 kg LEVAI, Levante
47 kg ZEHETNER, Akos
47 kg BOGDAN, Daniel



LISTA SUDIONIKA

XXVII. Međunarodni Božićni turnir GR

MLDJ GR

53 kg JUHASZ, Benjamin
53 kg OZSVALD, Kevin
85 kg SZABO, Balint

KLINČA SELA (KLS)

Wrestler / Lutteur

66 kg FILIPOVIĆ, Matija

LIKA (LIKA)

Wrestler / Lutteur

42 kg ČIBARIĆ, Sebastian
53 kg LJUBIĆ, Noa
53 kg ŠTAJDUHAR, Fran
59 kg FILAJDIĆ, Grga
73 kg TRAGER, Petar

LUDBREG (LUDB)

Wrestler / Lutteur

38 kg VAROVIĆ, Florijan

MACEDONIA ANC. R. YUG (MKD)

Wrestler / Lutteur

38 kg KAMBERI, Albin
42 kg REXHEPI, Venis
47 kg ZAIMI, Ardi
59 kg MEDI, Tarik

METALAC (MET)

Wrestler / Lutteur

53 kg PAŠKOV, Roko

MOLDOVA (MDA)

Wrestler / Lutteur

38 kg STRATANENCO, Iulian
59 kg SAIDOV, Saiddjafar
66 kg GUTU, Mihai

**MONTENEGRO (MNE)****Wrestler / Lutteur**

53 kg	RADOJEVIĆ, Matija
73 kg	DRAŠKOVIĆ, Luka

PETRINJA (PETR)**Wrestler / Lutteur**

38 kg	HORINEK, Filip
47 kg	GLAVAŠ, Lovro
59 kg	VIDOVIĆ, Valentino
85 kg	TOLIĆ, Filip

PIK VRBOVEC (PIKV)**Wrestler / Lutteur**

59 kg	BOLANT, Boris
-------	---------------

PODRAVKA (PODR)**Wrestler / Lutteur**

42 kg	LJUBIĆ, Borna
47 kg	RAKNIĆ, Patrik
59 kg	ADŽAGA, Ivan
66 kg	BENKO, Josip

POREČ (POR)**Wrestler / Lutteur**

53 kg	PAŠKVALIĆ, Ivan
-------	-----------------

RAVENNA (RAV)**Wrestler / Lutteur**

59 kg	RIVALTA, Noel
-------	---------------

ROMANIA (ROU)**Wrestler / Lutteur**

32 kg	MURARU, Alin
35 kg	RAIELANU, Luca



LISTA SUDIONIKA

XXVII. Međunarodni Božićni turnir GR

MLDJ GR

38 kg LUNGU, Constantin
38 kg MURARU, Georg-Cristian
47 kg ANDRONACHI, Traian

SERBIA (SRB)

Wrestler / Lutteur

35 kg STAJIN, Jovan
38 kg RADIŠIĆ, Nebojša
38 kg FRATRIĆ, Marko
42 kg SREMAC, Dragan
42 kg KOSTIĆ, Vuk
42 kg AVRAMOVIĆ, Marko
47 kg MIOLSKI, Jovan
47 kg JOVIŠIĆ, Simo
53 kg KURUČEV, Vanja
66 kg ĐUKIĆ, Branko
73 kg IKIĆ, Strahinja

SESVETE (SES)

Wrestler / Lutteur

38 kg BARIČEVIĆ, Dominik

SESVETSKI KRALJEVEC (SKR)

Wrestler / Lutteur

38 kg OSMANOVIĆ, Kristijan
47 kg ŠIMUNKOVIĆ, Reno
47 kg IVIĆ, Tomislav

SISAK (SIS)

Wrestler / Lutteur

42 kg CERJAK, Stipe
53 kg BARIĆ, Mateo

SLATINA (SLAT)

Wrestler / Lutteur

32 kg GARDILO, Patrik
38 kg GRUBAČ, Niko
42 kg PAVIĆ, Ino
66 kg KNEŽEVIĆ, Ivan



LISTA SUDIONIKA

XXVII. Međunarodni Božićni turnir GR

MLDJ GR

SWEDEN (SWE)

Wrestler / Lutteur

38 kg	GAMELIUS, Algot
42 kg	BINNATOV, Tural
47 kg	FOUGHANI, Adrian
53 kg	PADILLA, Elliot

ŠIBENIK (ŠIB)

Wrestler / Lutteur

47 kg	KLARIĆ, Marko
53 kg	SUNARA, Luka
66 kg	GRUBIŠIĆ, David
66 kg	STAMENKOVIĆ, Marko
85 kg	VUDRAG, Mate

TREŠNJEVKA (TREŠ)

Wrestler / Lutteur

53 kg	VIDOVIĆ, Danijel
-------	------------------

UKRAINE (UKR)

Wrestler / Lutteur

32 kg	BABINSKYI, Nazarii
38 kg	MILOV, Dmytro
42 kg	PASNAK, Anatolii
47 kg	RADYK, Maksym
59 kg	LIAKH, Ivan
73 kg	BARANOV, Pavlo

VELIKA GORICA 1991 (VG)

Wrestler / Lutteur

35 kg	ĐUKIĆ, Gabriel
42 kg	BEGANOVIĆ, Kristijan

VINDIJA (VIND)

Wrestler / Lutteur

42 kg	BENČEK, Cris
-------	--------------



LISTA SUDIONIKA

XXVII. Međunarodni Božićni turnir GR

MLDJ GR

47 kg GUŽVINEC, Andrija
53 kg PETRIĆ, Leon

ZADAR (ZD)

Wrestler / Lutteur

73 kg STRIKA, Roko

ZAGREB (ZGB)

Wrestler / Lutteur

42 kg MIHALIĆ, Sandro
47 kg LUKAČ, Antonio
53 kg DUKA, Noah
53 kg LUKAČ, Mihael
59 kg DIZDAR, Teo

Ekipe

	BOSNIA AND HERZEGOVINA	BIH
	CZECH REPUBLIC	CZE
	GOSPIĆ	GS
	GREECE	GRE
	HRVATSKI DRAGOVOLJAC	HD
	HUNGARY	HUN
	KLINČA SELA	KLS
	LIKA	LIKA
	LUDBREG	LUDB
	MACEDONIA ANC. R. YUG	MKD
	METALAC	MET
	MOLDOVA	MDA
	MONTENEGRO	MNE
	PETRINJA	PETR
	PIK VRBOVEC	PIKV
	PODRAVKA	PODR
	POREČ	POR
	RAVENNA	RAV
	ROMANIA	ROU
	SERBIA	SRB
	SESVETE	SES
	SESVETSKI KRALJEVEC	SKR
	SISAK	SIS
	SLATINA	SLAT
	SWEDEN	SWE
	ŠIBENIK	ŠIB
	TREŠNJEVKA	TREŠ
	UKRAINE	UKR
	VELIKA GORICA 1991	VG
	VINDIJA	VIND
	ZADAR	ZD
	ZAGREB	ZGB

Broj ekipa

32



BROJ NATJECATELJA PO EKIPI

XXVII. Međunarodni Božićni turnir GR

MLDJ GR

Ekipa	32 kg	35 kg	38 kg	42 kg	47 kg	53 kg	59 kg	66 kg	73 kg	85 kg	UKUPNO
BIH							1				1
CZE									1		1
GS						1					1
GRE			1	3	1	1	2	1			9
HD								1	1		2
HUN			2		3	2				1	8
KLS								1			1
LIKA				1		2	1		1		5
LUDB			1								1
MKD			1	1	1		1				4
MET						1					1
MDA			1				1	1			3
MNE						1			1		2
PETR			1		1		1			1	4
PIKV							1				1
PODR				1	1		1	1			4
POR						1					1
RAV							1				1
ROU	1	1	2		1						5
SRB		1	2	3	2	1		1	1		11
SES			1								1
SKR			1		2						3
SIS				1		1					2
SLAT	1		1	1				1			4
SWE			1	1	1	1					4
ŠIB					1	1		2		1	5
TREŠ						1					1
UKR	1		1	1	1		1		1		6
VG		1		1							2
VIND				1	1	1					3
ZD									1		1
ZGB				1	1	2	1				5
UKUPNO	3	3	16	16	17	17	12	9	7	3	103

Broj ekipa



TABLICA ELIMINACIJE

XXVII. Međunarodni Božićni turnir GR

MLDJ GR 32 kg

R.br.	Hrvač	Ekipa	1	2	3	PP	PL.
1	MURARU Alin	ROMANIA		4	4	8	1.
2	BABINSKYI Nazarii	UKRAINE	0		4	4	2.
3	GARDILO Patrik	SLATINA	0	0		0	3.

N1

1	4 0	MURARU Alin	ROU	P1 0	P2 0
2	0 0	BABINSKYI Nazarii	UKR	P1 0	P2 0

N2

3	0 0	GARDILO Patrik	SLA	P1 0	P2 0
1	4 0	MURARU Alin	ROU	P1 0	P2 0

N3

2	4 0	BABINSKYI Nazarii	UKR	P1 0	P2 0
3	0 0	GARDILO Patrik	SLA	P1 0	P2 0

KONAČNI POREDAK

Plasman	Hrvač	Ekipa
1	MURARU Alin	ROU
2	BABINSKYI Nazarii	UKR
3	GARDILO Patrik	SLAT

1 - Zlato



MURARU Alin

2 - Srebro



BABINSKYI Nazarii

3 - Bronca



GARDILO Patrik



Plasman	Ime	Ekipa	MT	MW	ML	CP	VF	VS	RS	TS	TG
1	MURARU Alin	ROU	2	2	0	8	0	2	0	0	0
2	BABINSKYI Nazarii	UKR	2	1	1	4	0	1	0	0	0
3	GARDILO Patrik	SLAT	2	0	2	0	0	0	0	0	0

MT - matches total, MW - matches won, ML - matches lost, CP - classification points, VF - match victories by fall, VS - match victories by superiority, RS - round victories by superiority, TS - technical points scored, TG - technical points given



DETALJI BORBI

XXVII. Međunarodni Božićni turnir GR

MLDJ GR 32 kg

10	N1	ROU	MURARU Alin	4	ST	0	0		
		UKR	BABINSKYI Nazarii	0		0	0		
31	N2	SLAT	GARDILO Patrik	0	ST	0	0		
		ROU	MURARU Alin	4		0	0		
44	N3	UKR	BABINSKYI Nazarii	4	ST	0	0		
		SLAT	GARDILO Patrik	0		0	0		



TECHNICAL POINTS SUMMARY

XXVII. Međunarodni Božićni turnir GR

MLDJ GR 32 kg

■ 1 point

■ 2 points

■ 4 points

■ 5 points

1. MURARU Alin	 ROU	0 (2m)
2. BABINSKYI Nazarii	 UKR	0 (2m)
3. GARDILO Patrik	SLAT	0 (2m)

0 TOTAL POINTS

3 TOTAL MATCHES

0,0 POINTS PER MATCH



TABLICA ELIMINACIJE

XXVII. Međunarodni Božićni turnir GR

MLDJ GR 35 kg

R.br.	Hrvač	Ekipa	1	2	3	PP	PL.
1	RAIELANU Luca	ROMANIA		5	1	6	2.
2	ĐUKIĆ Gabriel	VELIKA GORICA 19	0		0	0	3.
3	STAJIN Jovan	SERBIA	4	5		9	1.

N1

1	$\frac{5}{0}$	RAIELANU Luca	ROU	$\frac{P1}{0}$	$\frac{P2}{0}$
2	$\frac{0}{0}$	ĐUKIĆ Gabriel	VG	$\frac{P1}{0}$	$\frac{P2}{0}$

N2

3	$\frac{4}{0}$	STAJIN Jovan	SRB	$\frac{P1}{0}$	$\frac{P2}{0}$
1	$\frac{1}{0}$	RAIELANU Luca	ROU	$\frac{P1}{0}$	$\frac{P2}{0}$

N3

2	$\frac{0}{0}$	ĐUKIĆ Gabriel	VG	$\frac{P1}{0}$	$\frac{P2}{0}$
3	$\frac{5}{0}$	STAJIN Jovan	SRB	$\frac{P1}{0}$	$\frac{P2}{0}$

KONAČNI POREDAK

Plasman	Hrvač	Ekipa
1	STAJIN Jovan	SRB
2	RAIELANU Luca	ROU
3	ĐUKIĆ Gabriel	VG

1 - Zlato



STAJIN Jovan

2 - Srebro



RAIELANU Luca

3 - Bronca



ĐUKIĆ Gabriel



Plasman	Ime	Ekipa	MT	MW	ML	CP	VF	VS	RS	TS	TG
1	STAJIN Jovan	SRB	2	2	0	9	1	1	0	0	0
2	RAIELANU Luca	ROU	2	1	1	6	1	0	0	0	0
3	ĐUKIĆ Gabriel	VG	2	0	2	0	0	0	0	0	0

MT - matches total, MW - matches won, ML - matches lost, CP - classification points, VF - match victories by fall, VS - match victories by superiority, RS - round victories by superiority, TS - technical points scored, TG - technical points given



DETALJI BORBI

XXVII. Međunarodni Božićni turnir GR

MLDJ GR 35 kg

83	N1	ROU	RAIELANU Luca	5	VT		0		0	
		VG	ĐUKIĆ Gabriel	0			0		0	
100	N2	SRB	STAJIN Jovan	4	SP		0		0	
		ROU	RAIELANU Luca	1			0		0	
109	N3	VG	ĐUKIĆ Gabriel	0	VT		0		0	
		SRB	STAJIN Jovan	5			0		0	



TECHNICAL POINTS SUMMARY

XXVII. Međunarodni Božićni turnir GR

MLDJ GR 35 kg

■ 1 point

■ 2 points

■ 4 points

■ 5 points

1. STAJIN Jovan		SRB	0 (2m)
2. RAIELANU Luca		ROU	0 (2m)
3. ĐUKIĆ Gabriel		VG	0 (2m)

0 TOTAL POINTS

3 TOTAL MATCHES

0,0 POINTS PER MATCH



TABLICA ELIMINACIJE

XXVII. Međunarodni Božićni turnir GR

MLDJ GR 38 kg

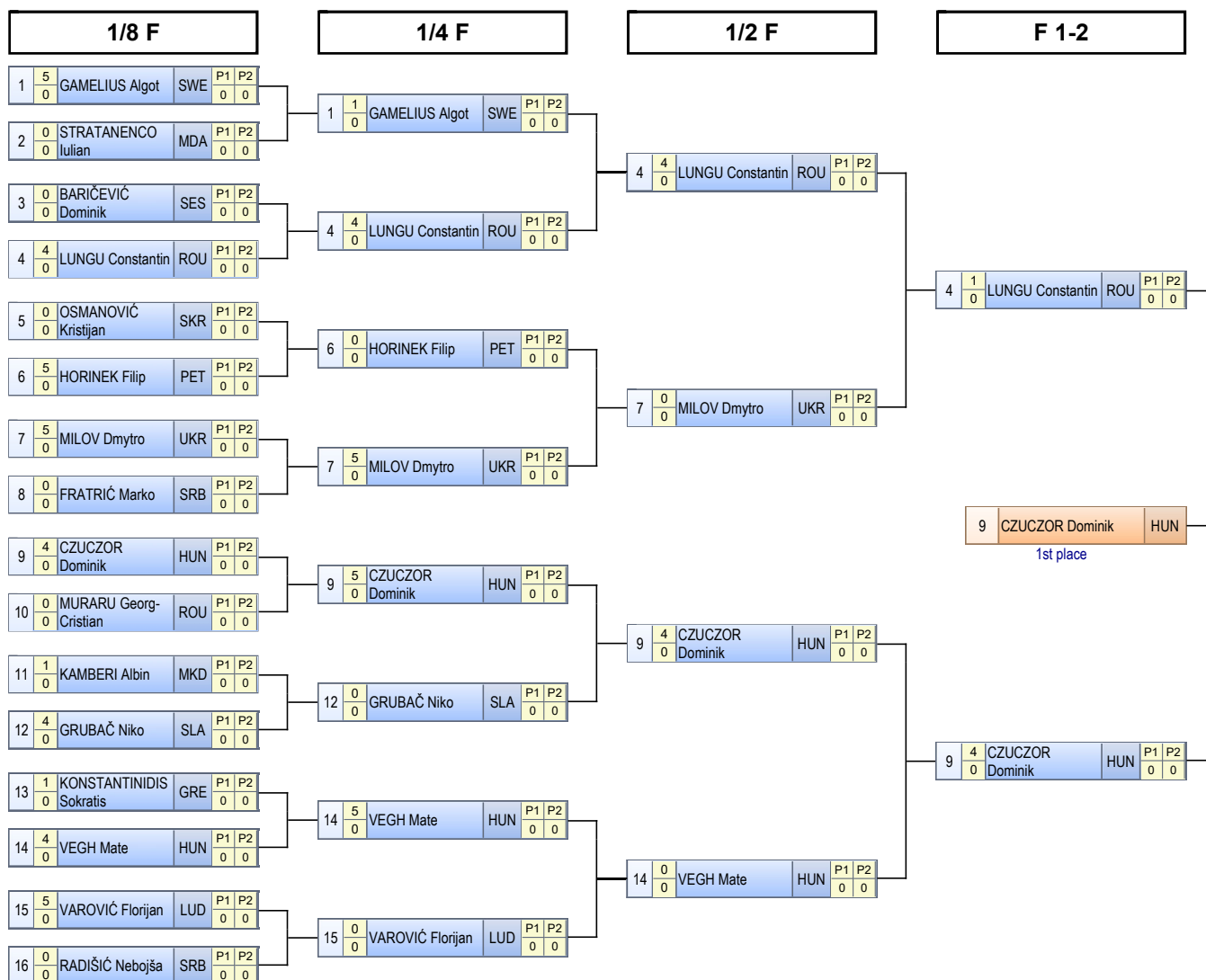

KONAČNI POREDAK

Plasman	Hrvač	Ekipa
1	CZUCZOR Dominik	HUN
2	LUNGU Constantin	ROU
3	GAMELIUS Algot	SWE
3	VEGH Mate	HUN
5	MILOV Dmytro	UKR
5	MURARU Georg-Cristian	ROU
7	HORINEK Filip	PETR
7	VAROVIĆ Florijan	LUDB
9	GRUBAČ Niko	SLAT
10	KAMBERI Albin	MKD
10	KONSTANTINIDIS Sokratis	GRE
12	STRATANENCO Iulian	MDA
12	BARIČEVIĆ Dominik	SES
12	OSMANOVIĆ Kristijan	SKR
12	FRATRIĆ Marko	SRB
12	RADIŠIĆ Nebojša	SRB

Repechage A

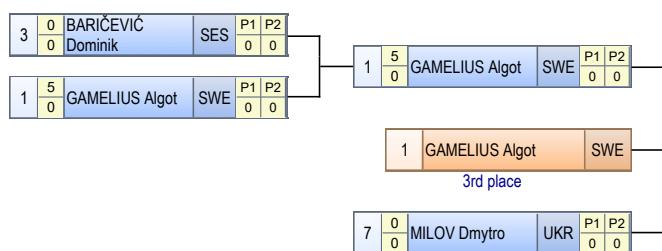

Repechage B

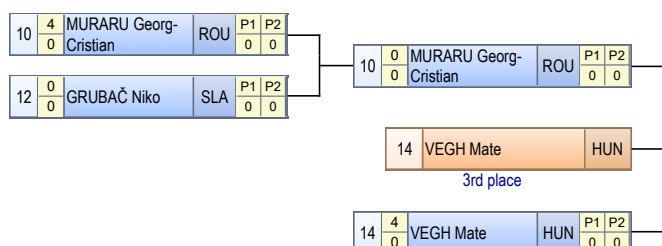

1 - Zlato

CZUCZOR Dominik
2 - Srebro

LUNGU Constantin
3 - Bronca

GAMELIUS Algot

VEGH Mate

Plasman	Ime	Ekipa	MT	MW	ML	CP	VF	VS	RS	TS	TG
1	CZUCZOR Dominik	HUN	4	4	0	17	1	3	0	0	0
2	LUNGU Constantin	ROU	4	3	1	13	0	3	0	0	0
3	GAMELIUS Algot	SWE	4	3	1	16	3	0	0	0	0
3	VEGH Mate	HUN	4	3	1	13	1	2	0	0	0
5	MILOV Dmytro	UKR	4	2	2	10	2	0	0	0	0
5	MURARU Georg-Cristian	ROU	3	1	2	4	0	1	0	0	0
7	HORINEK Filip	PETR	2	1	1	5	1	0	0	0	0
7	VAROVIĆ Florijan	LUDB	2	1	1	5	1	0	0	0	0
9	GRUBAČ Niko	SLAT	3	1	2	4	0	1	0	0	0
10	KAMBERI Albin	MKD	1	0	1	1	0	0	0	0	0
10	KONSTANTINIDIS Sokratis	GRE	1	0	1	1	0	0	0	0	0
12	STRATANENCO Iulian	MDA	1	0	1	0	0	0	0	0	0
12	BARIČEVIĆ Dominik	SES	2	0	2	0	0	0	0	0	0
12	OSMANOVIĆ Kristijan	SKR	1	0	1	0	0	0	0	0	0
12	FRATRIĆ Marko	SRB	1	0	1	0	0	0	0	0	0
12	RADIŠIĆ Nebojša	SRB	1	0	1	0	0	0	0	0	0

MT - matches total, **MW** - matches won, **ML** - matches lost, **CP** - classification points, **VF** - match victories by fall, **VS** - match victories by superiority,
RS - round victories by superiority, **TS** - technical points scored, **TG** - technical points given



DETALJI BORBI

XXVII. Međunarodni Božićni turnir GR

MLDJ GR 38 kg

66	1/8 F	SWE	GAMELIUS Algot	5	VT	0	0		
		MDA	STRATANENCO Iulian	0		0	0		
67	1/8 F	SES	BARIČEVIĆ Dominik	0	ST	0	0		
		ROU	LUNGU Constantin	4		0	0		
68	1/8 F	SKR	OSMANOVIĆ Kristijan	0	VT	0	0		
		PETR	HORINEK Filip	5		0	0		
69	1/8 F	UKR	MILOV Dmytro	5	VT	0	0		
		SRB	FRATRIĆ Marko	0		0	0		
70	1/8 F	HUN	CZUCZOR Dominik	4	ST	0	0		
		ROU	MURARU Georg-Cristian	0		0	0		
71	1/8 F	MKD	KAMBERI Albin	1	SP	0	0		
		SLAT	GRUBAČ Niko	4		0	0		
72	1/8 F	GRE	KONSTANTINIDIS Sokrat	1	SP	0	0		
		HUN	VEGH Mate	4		0	0		
73	1/8 F	LUDB	VAROVIĆ Florijan	5	VT	0	0		
		SRB	RADIŠIĆ Nebojša	0		0	0		
84	1/4 F	SWE	GAMELIUS Algot	1	SP	0	0		
		ROU	LUNGU Constantin	4		0	0		
85	1/4 F	PETR	HORINEK Filip	0	VT	0	0		
		UKR	MILOV Dmytro	5		0	0		
86	1/4 F	HUN	CZUCZOR Dominik	5	VT	0	0		
		SLAT	GRUBAČ Niko	0		0	0		
87	1/4 F	HUN	VEGH Mate	5	VT	0	0		
		LUDB	VAROVIĆ Florijan	0		0	0		
101	1/2 F	ROU	LUNGU Constantin	4	ST	0	0		
		UKR	MILOV Dmytro	0		0	0		
102	1/2 F	HUN	CZUCZOR Dominik	4	ST	0	0		
		HUN	VEGH Mate	0		0	0		
112	RB1	ROU	MURARU Georg-Cristian	4	ST	0	0		
		SLAT	GRUBAČ Niko	0		0	0		
113	RA1	SES	BARIČEVIĆ Dominik	0	VT	0	0		
		SWE	GAMELIUS Algot	5		0	0		
116	F 3-5	ROU	MURARU Georg-Cristian	0	ST	0	0		
		HUN	VEGH Mate	4		0	0		
117	F 3-5	SWE	GAMELIUS Algot	5	VT	0	0		
		UKR	MILOV Dmytro	0		0	0		
125	F 1-2	ROU	LUNGU Constantin	1	SP	0	0		
		HUN	CZUCZOR Dominik	4		0	0		



TECHNICAL POINTS SUMMARY

XXVII. Međunarodni Božićni turnir GR

MLDJ GR 38 kg

■ 1 point ■ 2 points ■ 4 points ■ 5 points

1.	CZUCZOR Dominik	 HUN	0 (4m)
2.	LUNGU Constantin	 ROU	0 (4m)
3.	GAMELIUS Algot	 SWE	0 (4m)
3.	VEGH Mate	 HUN	0 (4m)
5.	MILOV Dmytro	 UKR	0 (4m)
5.	MURARU Georg-Cristian	 ROU	0 (3m)
7.	HORINEK Filip	· PETR	0 (2m)
7.	VAROVIĆ Florijan	· LUDB	0 (2m)
9.	GRUBAČ Niko	· SLAT	0 (3m)
10.	KAMBERI Albin	 MKD	0 (1m)
10.	KONSTANTINIDIS Sokratis	 GRE	0 (1m)
12.	STRATANENCO Iulian	 MDA	0 (1m)
12.	BARIČEVIĆ Dominik	· SES	0 (2m)
12.	OSMANOVIĆ Kristijan	· SKR	0 (1m)
12.	FRATRIĆ Marko	 SRB	0 (1m)
12.	RADIŠIĆ Nebojša	 SRB	0 (1m)

0 TOTAL POINTS 19 TOTAL MATCHES 0,0 POINTS PER MATCH



TABLICA ELIMINACIJE

XXVII. Međunarodni Božićni turnir GR

MLDJ GR 42 kg

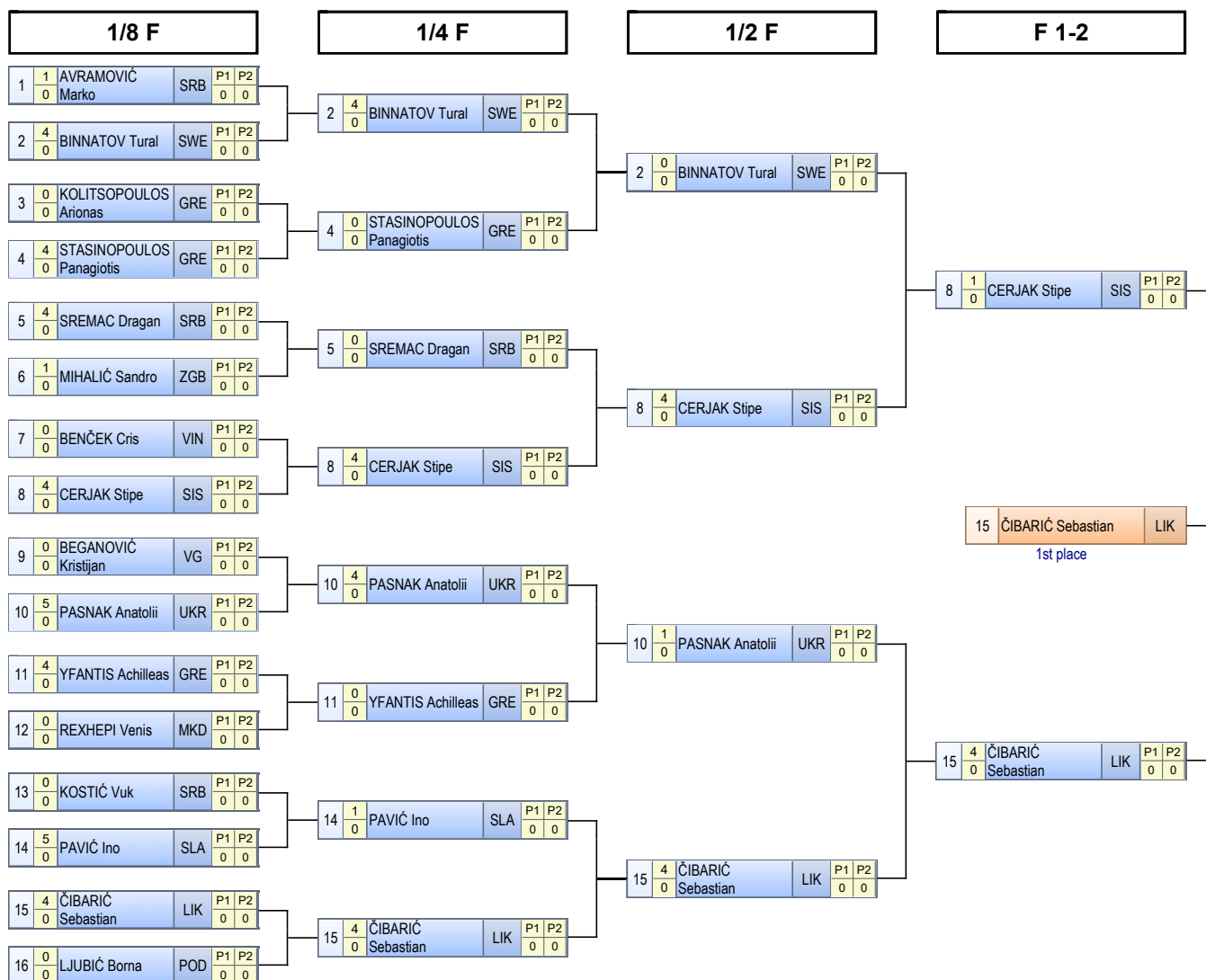

Repechage A

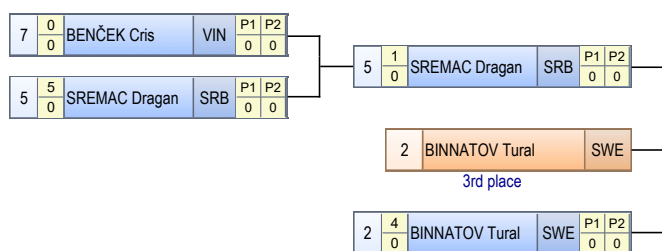

Repechage B

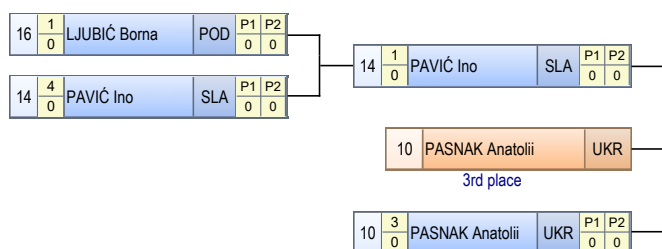

KONAČNI POREDAK

Plasman	Hrvač	Ekipa
1	ČIBARIĆ Sebastian	LIKA
2	CERJAK Stipe	SIS
3	BINNATOV Tural	SWE
3	PASNAK Anatolii	UKR
5	SREMAC Dragan	SRB
5	PAVIĆ Ino	SLAT
7	STASINOPOULOS Panagiotis	GRE
7	YFANTIS Achilleas	GRE
9	AVRAMOVIĆ Marko	SRB
9	MIHALIĆ Sandro	ZGB
9	LJUBIĆ Borna	PODR
12	KOLITSOPOULOS Arionas	GRE
12	BENČEK Cris	VIND
12	BEGANOVIĆ Kristijan	VG
12	REXHEPI Venis	MKD
12	KOŠTIĆ Vuk	SRB

1 - Zlato

ČIBARIĆ Sebastian
2 - Srebro

CERJAK Stipe
3 - Bronca

BINNATOV Tural

PASNAK Anatolii

Plasman	Ime	Ekipa	MT	MW	ML	CP	VF	VS	RS	TS	TG
1	ČIBARIĆ Sebastian	LIKA	4	4	0	16	0	4	0	0	0
2	CERJAK Stipe	SIS	4	3	1	13	0	3	0	0	0
3	BINNATOV Tural	SWE	4	3	1	12	0	3	0	0	0
3	PASNAK Anatolii	UKR	4	3	1	13	1	1	0	0	0
5	SREMAC Dragan	SRB	4	2	2	10	1	1	0	0	0
5	PAVIĆ Ino	SLAT	4	2	2	11	1	1	0	0	0
7	STASINOPOULOS Panagiotis	GRE	2	1	1	4	0	1	0	0	0
7	YFANTIS Achilleas	GRE	2	1	1	4	0	1	0	0	0
9	AVRAMOVIĆ Marko	SRB	1	0	1	1	0	0	0	0	0
9	MIHALIĆ Sandro	ZGB	1	0	1	1	0	0	0	0	0
9	LJUBIĆ Borna	PODR	2	0	2	1	0	0	0	0	0
12	KOLITSOPOULOS Arionas	GRE	1	0	1	0	0	0	0	0	0
12	BENČEK Cris	VIND	2	0	2	0	0	0	0	0	0
12	BEGANOVIĆ Kristijan	VG	1	0	1	0	0	0	0	0	0
12	REXHEPI Venis	MKD	1	0	1	0	0	0	0	0	0
12	KOSTIĆ Vuk	SRB	1	0	1	0	0	0	0	0	0

MT - matches total, **MW** - matches won, **ML** - matches lost, **CP** - classification points, **VF** - match victories by fall, **VS** - match victories by superiority,
RS - round victories by superiority, **TS** - technical points scored, **TG** - technical points given



DETALJI BORBI

XXVII. Međunarodni Božićni turnir GR

MLDJ GR 42 kg

75	1/8 F	SRB	AVRAMOVIĆ Marko	1	SP	0	0		
		SWE	BINNATOV Tural	4		0	0		
76	1/8 F	GRE	KOLITSOPOULOS Arion	0	ST	0	0		
		GRE	STASINOPOULOS Panagiotis	4		0	0		
77	1/8 F	SRB	SREMAC Dragan	4	SP	0	0		
		ZGB	MIHALIĆ Sandro	1		0	0		
78	1/8 F	VIND	BENČEK Cris	0	ST	0	0		
		SIS	CERJAK Stipe	4		0	0		
79	1/8 F	VG	BEGANOVIĆ Kristijan	0	VT	0	0		
		UKR	PASNAK Anatolii	5		0	0		
80	1/8 F	GRE	YFANTIS Achilleas	4	ST	0	0		
		MKD	REXHEPI Venis	0		0	0		
81	1/8 F	SRB	KOSTIĆ Vuk	0	VT	0	0		
		SLAT	PAVIĆ Ino	5		0	0		
82	1/8 F	LIKA	ČIBARIĆ Sebastian	4	ST	0	0		
		PODR	LJUBIĆ Borna	0		0	0		
96	1/4 F	SWE	BINNATOV Tural	4	ST	0	0		
		GRE	STASINOPOULOS Panagiotis	0		0	0		
97	1/4 F	SRB	SREMAC Dragan	0	ST	0	0		
		SIS	CERJAK Stipe	4		0	0		
98	1/4 F	UKR	PASNAK Anatolii	4	ST	0	0		
		GRE	YFANTIS Achilleas	0		0	0		
99	1/4 F	SLAT	PAVIĆ Ino	1	SP	0	0		
		LIKA	ČIBARIĆ Sebastian	4		0	0		
107	1/2 F	SWE	BINNATOV Tural	0	ST	0	0		
		SIS	CERJAK Stipe	4		0	0		
108	1/2 F	UKR	PASNAK Anatolii	1	SP	0	0		
		LIKA	ČIBARIĆ Sebastian	4		0	0		
114	RB1	PODR	LJUBIĆ Borna	1	SP	0	0		
		SLAT	PAVIĆ Ino	4		0	0		
115	RA1	VIND	BENČEK Cris	0	VT	0	0		
		SRB	SREMAC Dragan	5		0	0		
120	F 3-5	SLAT	PAVIĆ Ino	1	PP	0	0		
		UKR	PASNAK Anatolii	3		0	0		
121	F 3-5	SRB	SREMAC Dragan	1	SP	0	0		
		SWE	BINNATOV Tural	4		0	0		
127	F 1-2	SIS	CERJAK Stipe	1	SP	0	0		
		LIKA	ČIBARIĆ Sebastian	4		0	0		



TECHNICAL POINTS SUMMARY

XXVII. Međunarodni Božićni turnir GR

MLDJ GR 42 kg

■ 1 point ■ 2 points ■ 4 points ■ 5 points

1.	ČIBARIĆ Sebastian	·	LIKA	0 (4m)
2.	CERJAK Stipe	·	SIS	0 (4m)
3.	BINNATOV Tural		SWE	0 (4m)
3.	PASNAK Anatolii		UKR	0 (4m)
5.	SREMAC Dragan		SRB	0 (4m)
5.	PAVIĆ Ino	·	SLAT	0 (4m)
7.	STASIÑOPOULOS Panagiotis		GRE	0 (2m)
7.	YFANTIS Achilleas		GRE	0 (2m)
9.	AVRAMOVIĆ Marko		SRB	0 (1m)
9.	MIHALIĆ Sandro	·	ZGB	0 (1m)
9.	LJUBIĆ Borna	·	PODR	0 (2m)
12.	KOLITSOPOULOS Arionas		GRE	0 (1m)
12.	BENČEK Cris	·	VIND	0 (2m)
12.	BEGANOVIĆ Kristijan	·	VG	0 (1m)
12.	REXHEPI Venis		MKD	0 (1m)
12.	KOSTIĆ Vuk		SRB	0 (1m)

0 TOTAL POINTS 19 TOTAL MATCHES 0,0 POINTS PER MATCH



TABLICA ELIMINACIJE

XXVII. Međunarodni Božićni turnir GR

MLDJ GR 47 kg

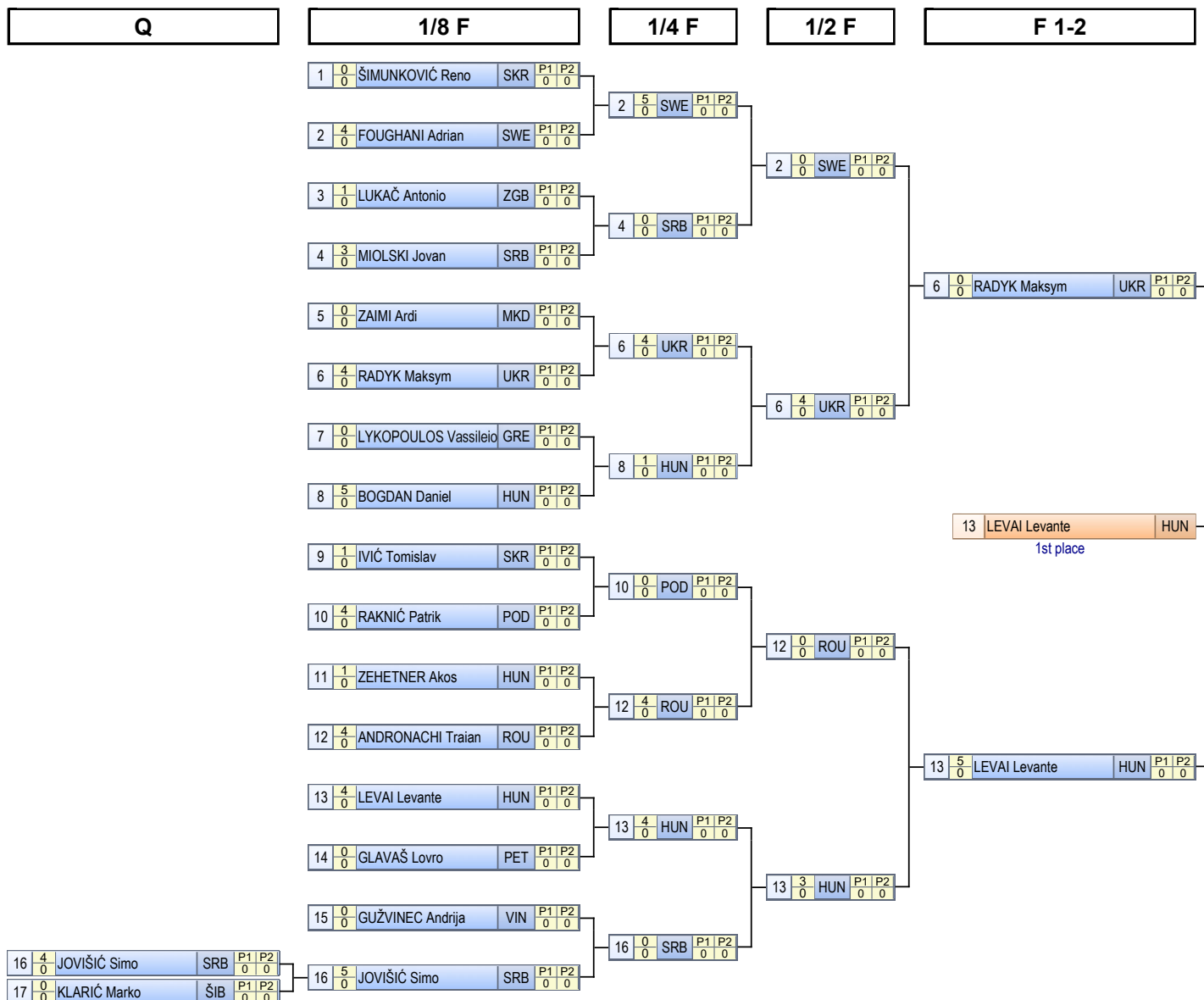

Repechage A

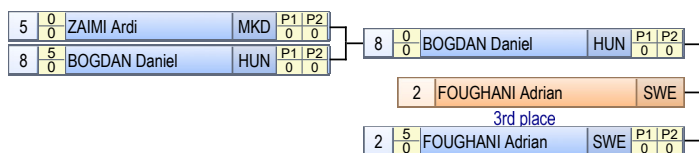

Repechage B

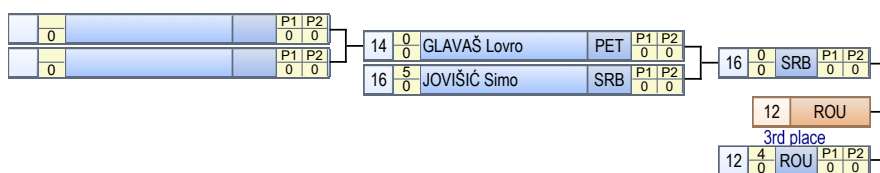

KONAČNI POREDAK

Plasman	Hrvač	Ekipa
1	LEVAI Levante	HUN
2	RADYK Maksym	UKR
3	FOUGHANI Adrian	SWE
3	ANDRONACHI Traian	ROU
5	BOGDAN Daniel	HUN
5	JOVIŠIĆ Simo	SRB
7	RAKNIĆ Patrik	PODR
8	MIOLSKI Jovan	SRB
9	LUKAČ Antonio	ZGB
9	IVIĆ Tomislav	SKR
9	ZEHETNER Akos	HUN
12	ŠIMUNKOVIĆ Reno	SKR
12	ZAIMI Ardi	MKD
12	LYKOPOULOS Vassileios	GRE
12	GLAVAŠ Lovro	PETR
12	GUŽVINEC Andrija	VIND
12	KLARIĆ Marko	ŠIB

1 - Zlato

LEVAI Levante
2 - Srebro

RADYK Maksym
3 - Bronca

FOUGHANI Adrian

ANDRONACHI Traian

Plasman	Ime	Ekipa	MT	MW	ML	CP	VF	VS	RS	TS	TG
1	LEVAI Levante	HUN	4	4	0	16	1	2	0	0	0
2	RADYK Maksym	UKR	4	3	1	12	0	3	0	0	0
3	FOUGHANI Adrian	SWE	4	3	1	14	2	1	0	0	0
3	ANDRONACHI Traian	ROU	4	3	1	12	0	3	0	0	0
5	BOGDAN Daniel	HUN	4	2	2	11	2	0	0	0	0
5	JOVIŠIĆ Simo	SRB	5	3	2	14	2	1	0	0	0
7	RAKNIĆ Patrik	PODR	2	1	1	4	0	1	0	0	0
8	MIOLSKI Jovan	SRB	2	1	1	3	0	0	0	0	0
9	LUKAČ Antonio	ZGB	1	0	1	1	0	0	0	0	0
9	IVIĆ Tomislav	SKR	1	0	1	1	0	0	0	0	0
9	ZEHETNER Akos	HUN	1	0	1	1	0	0	0	0	0
12	ŠIMUNKOVIĆ Reno	SKR	1	0	1	0	0	0	0	0	0
12	ZAIMI Ardi	MKD	2	0	2	0	0	0	0	0	0
12	LYKOPOULOS Vassileios	GRE	1	0	1	0	0	0	0	0	0
12	GLAVAŠ Lovro	PETR	2	0	2	0	0	0	0	0	0
12	GUŽVINEC Andrija	VIND	1	0	1	0	0	0	0	0	0
12	KLARIĆ Marko	ŠIB	1	0	1	0	0	0	0	0	0

MT - matches total, MW - matches won, ML - matches lost, CP - classification points, VF - match victories by fall, VS - match victories by superiority, RS - round victories by superiority, TS - technical points scored, TG - technical points given



DETALJI BORBI

XXVII. Međunarodni Božićni turnir GR

MLDJ GR 47 kg

74	Q	SRB	JOVIŠIĆ Simo	4	ST	0	0		
		ŠIB	KLARIĆ Marko	0		0	0		
88	1/8 F	SKR	ŠIMUNKOVIĆ Reno	0	ST	0	0		
		SWE	FOUGHANI Adrian	4		0	0		
89	1/8 F	ZGB	LUKAČ Antonio	1	PP	0	0		
		SRB	MIOLSKI Jovan	3		0	0		
90	1/8 F	MKD	ZAIMI Ardi	0	ST	0	0		
		UKR	RADYK Maksym	4		0	0		
91	1/8 F	GRE	LYKOPOULOS Vassileio	0	VT	0	0		
		HUN	BOGDAN Daniel	5		0	0		
92	1/8 F	SKR	IVIĆ Tomislav	1	SP	0	0		
		PODR	RAKNIĆ Patrik	4		0	0		
93	1/8 F	HUN	ZEHETNER Akos	1	SP	0	0		
		ROU	ANDRONACHI Traian	4		0	0		
94	1/8 F	HUN	LEVAI Levante	4	ST	0	0		
		PETR	GLAVAŠ Lovro	0		0	0		
95	1/8 F	VIND	GUŽVINEC Andrija	0	VT	0	0		
		SRB	JOVIŠIĆ Simo	5		0	0		
103	1/4 F	SWE	FOUGHANI Adrian	5	VT	0	0		
		SRB	MIOLSKI Jovan	0		0	0		
104	1/4 F	UKR	RADYK Maksym	4	SP	0	0		
		HUN	BOGDAN Daniel	1		0	0		
105	1/4 F	PODR	RAKNIĆ Patrik	0	ST	0	0		
		ROU	ANDRONACHI Traian	4		0	0		
106	1/4 F	HUN	LEVAI Levante	4	ST	0	0		
		SRB	JOVIŠIĆ Simo	0		0	0		
110	1/2 F	SWE	FOUGHANI Adrian	0	ST	0	0		
		UKR	RADYK Maksym	4		0	0		
111	1/2 F	ROU	ANDRONACHI Traian	0	PO	0	0		
		HUN	LEVAI Levante	3		0	0		
119	RA1	MKD	ZAIMI Ardi	0	VT	0	0		
		HUN	BOGDAN Daniel	5		0	0		
122	RB2	PETR	GLAVAŠ Lovro	0	VT	0	0		
		SRB	JOVIŠIĆ Simo	5		0	0		
123	F 3-5	HUN	BOGDAN Daniel	0	VT	0	0		
		SWE	FOUGHANI Adrian	5		0	0		
124	F 3-5	SRB	JOVIŠIĆ Simo	0	ST	0	0		
		ROU	ANDRONACHI Traian	4		0	0		



DETALJI BORBI

XXVII. Međunarodni Božićni turnir GR

MLDJ GR 47 kg

126	F 1-2	UKR	RADYK Maksym	0	VT		0		0	
		HUN	LEVAI Levante	5			0		0	



TECHNICAL POINTS SUMMARY

XXVII. Međunarodni Božićni turnir GR

MLDJ GR 47 kg

■ 1 point ■ 2 points ■ 4 points ■ 5 points

1.	LEVAI Levante		HUN	0 (4m)
2.	RADYK Maksym		UKR	0 (4m)
3.	FOUGHANI Adrian		SWE	0 (4m)
3.	ANDRONACHI Traian		ROU	0 (4m)
5.	BOGDAN Daniel		HUN	0 (4m)
5.	JOVIŠIĆ Simo		SRB	0 (5m)
7.	RAKNIĆ Patrik	·	PODR	0 (2m)
8.	MIOLSKI Jovan		SRB	0 (2m)
9.	LUKAČ Antonio	·	ZGB	0 (1m)
9.	IVIĆ Tomislav	·	SKR	0 (1m)
9.	ZEHEKNER Akos		HUN	0 (1m)
12.	ŠIMUNKOVIĆ Reno	·	SKR	0 (1m)
12.	ZAIMI Ardi		MKD	0 (2m)
12.	LYKOPOULOS Vassileios		GRE	0 (1m)
12.	GLAVAŠ Lovro	·	PETR	0 (2m)
12.	GUŽVINEC Andrija	·	VIND	0 (1m)
12.	KLARIĆ Marko	·	ŠIB	0 (1m)

0 TOTAL POINTS 20 TOTAL MATCHES 0,0 POINTS PER MATCH



TABLICA ELIMINACIJE

XXVII. Međunarodni Božićni turnir GR

MLDJ GR 53 kg

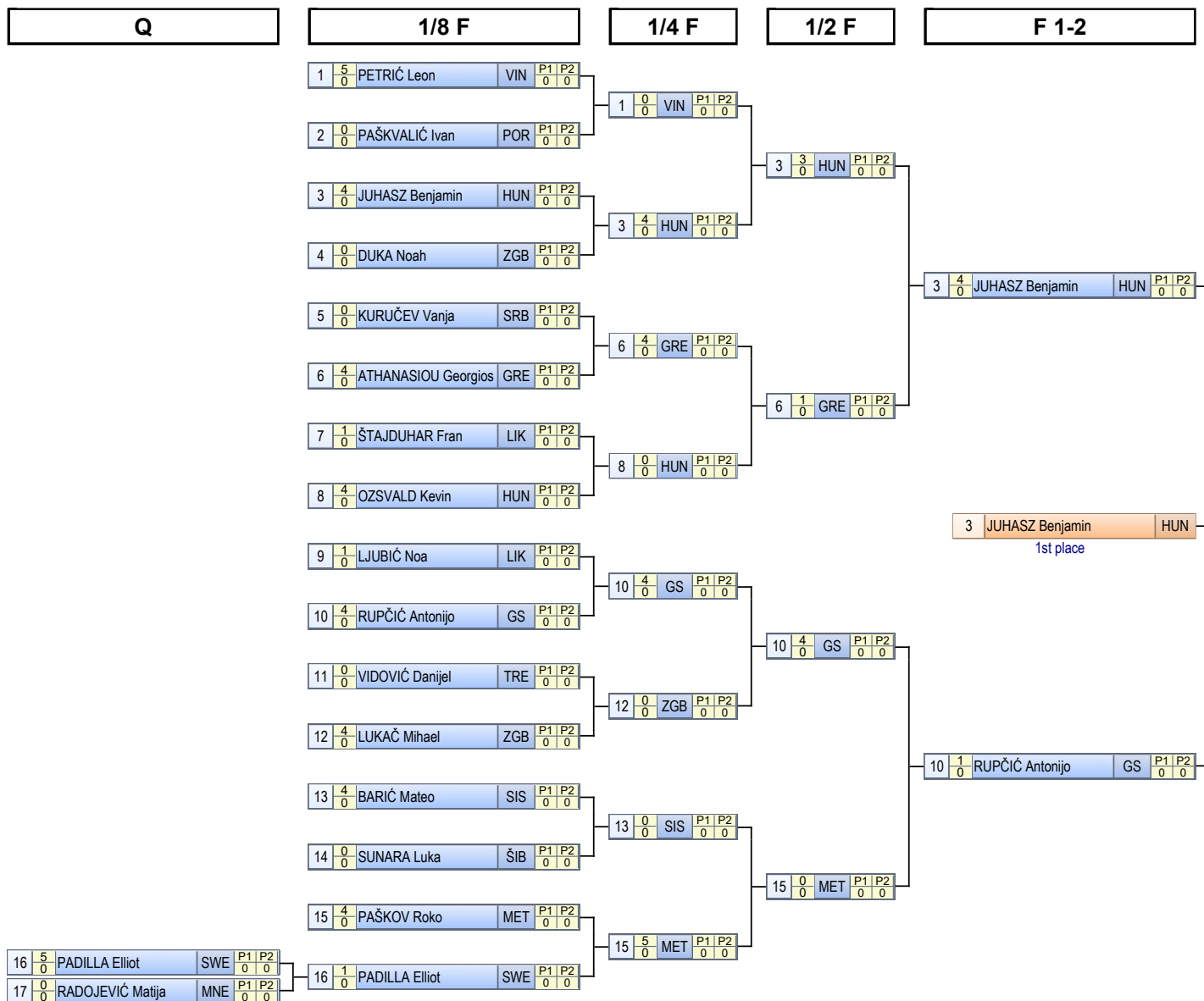

KONAČNI POREDAK

Plasman	Hrvač	Ekipa
1	JUHASZ Benjamin	HUN
2	RUPČIĆ Antonijo	GS
3	ATHANASIOU Georgios	GRE
3	LUKAČ Mihael	ZGB
5	PETRIĆ Leon	VIND
5	PAŠKOV Roko	MET
7	PADILLA Elliot	SWE
8	OZSVALD Kevin	HUN
8	BARIĆ Mateo	SIS
10	LJUBIĆ Noa	LIKA
11	ŠTAJDUHAR Fran	LIKA
12	PAŠKVALIĆ Ivan	POR
12	DUKA Noah	ZGB
12	KURUČEV Vanja	SRB
12	VIDOVIĆ Danijel	TREŠ
12	SUNARA Luka	ŠIB
12	RADOJEVIĆ Matija	MNE

Repechage A

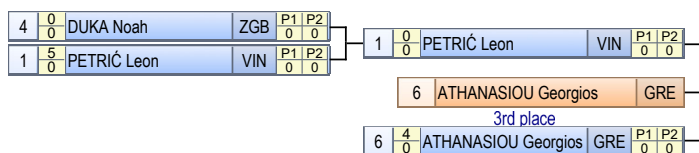

Repechage B

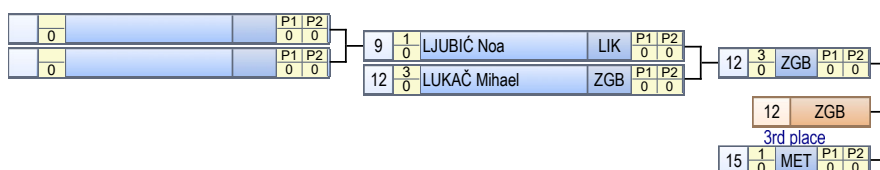

1 - Zlato

JUHASZ Benjamin
2 - Srebro

RUPČIĆ Antonijo
3 - Bronca

ATHANASIOU Georgios

LUKAČ Mihael

Plasman	Ime	Ekipa	MT	MW	ML	CP	VF	VS	RS	TS	TG
1	JUHASZ Benjamin	HUN	4	4	0	15	0	3	0	0	0
2	RUPČIĆ Antonijo	GS	4	3	1	13	0	3	0	0	0
3	ATHANASIOU Georgios	GRE	4	3	1	13	0	3	0	0	0
3	LUKAČ Mihael	ZGB	4	3	1	10	0	1	0	0	0
5	PETRIĆ Leon	VIND	4	2	2	10	2	0	0	0	0
5	PAŠKOV Roko	MET	4	2	2	10	1	1	0	0	0
7	PADILLA Elliot	SWE	2	1	1	6	1	0	0	0	0
8	OZSVALD Kevin	HUN	2	1	1	4	0	1	0	0	0
8	BARIĆ Mateo	SIS	2	1	1	4	0	1	0	0	0
10	LJUBIĆ Noa	LIKA	2	0	2	2	0	0	0	0	0
11	ŠTAJDUHAR Fran	LIKA	1	0	1	1	0	0	0	0	0
12	PAŠKVALIĆ Ivan	POR	1	0	1	0	0	0	0	0	0
12	DUKA Noah	ZGB	2	0	2	0	0	0	0	0	0
12	KURUČEV Vanja	SRB	1	0	1	0	0	0	0	0	0
12	VIDOVIĆ Danijel	TREŠ	1	0	1	0	0	0	0	0	0
12	SUNARA Luka	ŠIB	1	0	1	0	0	0	0	0	0
12	RADOJEVIĆ Matija	MNE	1	0	1	0	0	0	0	0	0

MT - matches total, **MW** - matches won, **ML** - matches lost, **CP** - classification points, **VF** - match victories by fall, **VS** - match victories by superiority,
RS - round victories by superiority, **TS** - technical points scored, **TG** - technical points given



DETALJI BORBI

XXVII. Međunarodni Božićni turnir GR

MLDJ GR 53 kg

1	Q	SWE	PADILLA Elliot	5	VT	0	0		
		MNE	RADOJEVIĆ Matija	0		0	0		
12	1/8 F	VIND	PETRIĆ Leon	5	VT	0	0		
		POR	PAŠKVALIĆ Ivan	0		0	0		
13	1/8 F	HUN	JUHASZ Benjamin	4	ST	0	0		
		ZGB	DUKA Noah	0		0	0		
14	1/8 F	SRB	KURUČEV Vanja	0	ST	0	0		
		GRE	ATHANASIOU Georgios	4		0	0		
15	1/8 F	LIKA	ŠTAJDUHAR Fran	1	SP	0	0		
		HUN	OZSVALD Kevin	4		0	0		
16	1/8 F	LIKA	LJUBIĆ Noa	1	SP	0	0		
		GS	RUPČIĆ Antonijo	4		0	0		
17	1/8 F	TREŠ	VIDOVIĆ Danijel	0	ST	0	0		
		ZGB	LUKAČ Mihael	4		0	0		
18	1/8 F	SIS	BARIĆ Mateo	4	ST	0	0		
		ŠIB	SUNARA Luka	0		0	0		
19	1/8 F	MET	PAŠKOV Roko	4	SP	0	0		
		SWE	PADILLA Elliot	1		0	0		
33	1/4 F	VIND	PETRIĆ Leon	0	ST	0	0		
		HUN	JUHASZ Benjamin	4		0	0		
34	1/4 F	GRE	ATHANASIOU Georgios	4	ST	0	0		
		HUN	OZSVALD Kevin	0		0	0		
35	1/4 F	GS	RUPČIĆ Antonijo	4	ST	0	0		
		ZGB	LUKAČ Mihael	0		0	0		
36	1/4 F	SIS	BARIĆ Mateo	0	VT	0	0		
		MET	PAŠKOV Roko	5		0	0		
46	1/2 F	HUN	JUHASZ Benjamin	3	PP	0	0		
		GRE	ATHANASIOU Georgios	1		0	0		
47	1/2 F	GS	RUPČIĆ Antonijo	4	ST	0	0		
		MET	PAŠKOV Roko	0		0	0		
54	RA1	ZGB	DUKA Noah	0	VT	0	0		
		VIND	PETRIĆ Leon	5		0	0		
59	RB2	LIKA	LJUBIĆ Noa	1	PP	0	0		
		ZGB	LUKAČ Mihael	3		0	0		
60	F 3-5	VIND	PETRIĆ Leon	0	ST	0	0		
		GRE	ATHANASIOU Georgios	4		0	0		
61	F 3-5	ZGB	LUKAČ Mihael	3	PP	0	0		
		MET	PAŠKOV Roko	1		0	0		



DETALJI BORBI

XXVII. Međunarodni Božićni turnir GR

MLDJ GR 53 kg

62	F 1-2	HUN	JUHASZ Benjamin	4	SP		0		0	
		GS	RUPČIĆ Antonijo	1			0		0	



TECHNICAL POINTS SUMMARY

XXVII. Međunarodni Božićni turnir GR

MLDJ GR 53 kg

■ 1 point ■ 2 points ■ 4 points ■ 5 points

1.	JUHASZ Benjamin		HUN	0	(4m)
2.	RUPČIĆ Antonijo	·	GS	0	(4m)
3.	ATHANASIOU Georgios		GRE	0	(4m)
3.	LUKAČ Mihael	·	ZGB	0	(4m)
5.	PETRIĆ Leon	·	VIND	0	(4m)
5.	PAŠKOV Roko	·	MET	0	(4m)
7.	PADILLA Elliot		SWE	0	(2m)
8.	OZSVALD Kevin		HUN	0	(2m)
8.	BARIĆ Mateo	·	SIS	0	(2m)
10.	LJUBIĆ Noa	·	LIKA	0	(2m)
11.	ŠTAJDUHAR Fran	·	LIKA	0	(1m)
12.	PAŠKVALIĆ Ivan	·	POR	0	(1m)
12.	DUKA Noah	·	ZGB	0	(2m)
12.	KURUČEV Vanja		SRB	0	(1m)
12.	VIDOVIĆ Danijel	·	TREŠ	0	(1m)
12.	SUNARA Luka	·	ŠIB	0	(1m)
12.	RADOJEVIĆ Matija		MNE	0	(1m)

0 TOTAL POINTS 20 TOTAL MATCHES 0,0 POINTS PER MATCH



TABLICA ELIMINACIJE

XXVII. Međunarodni Božićni turnir GR

MLDJ GR 59 kg

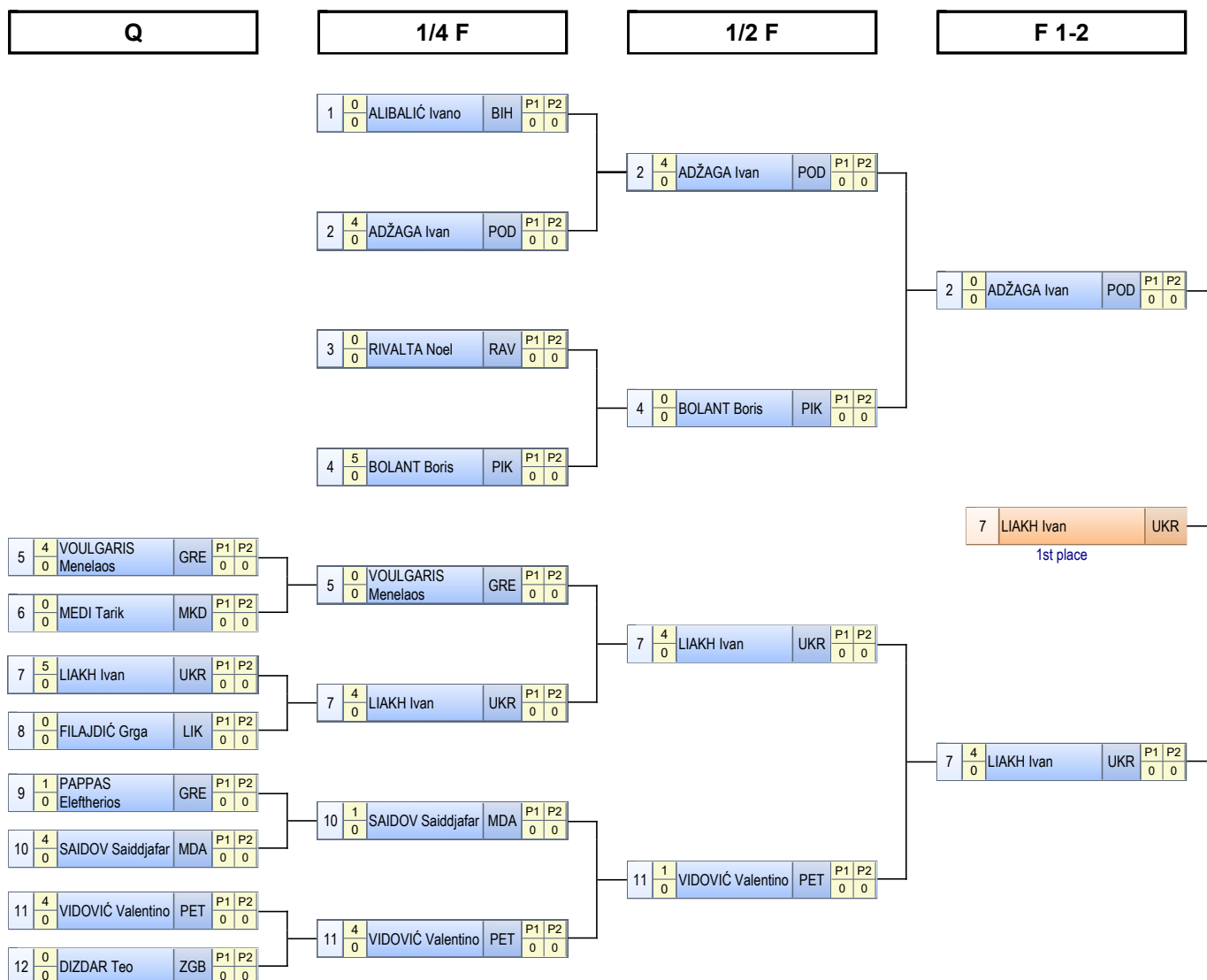

Repechage A

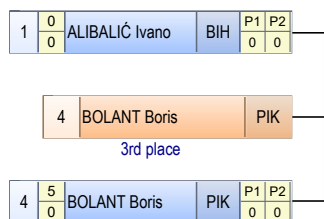

Repechage B

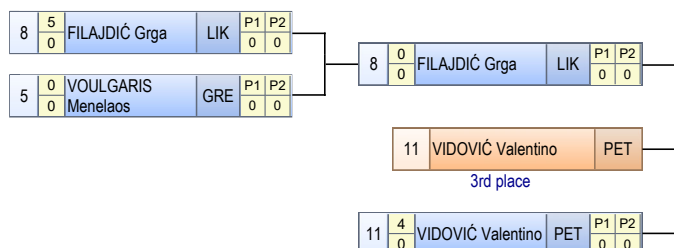

KONAČNI POREDAK

Plasman	Hrvač	Ekipa
1	LIAKH Ivan	UKR
2	ADŽAGA Ivan	PODR
3	BOLANT Boris	PIKV
3	VIDOVIĆ Valentino	PETR
5	ALIBALIĆ Ivano	BIH
5	FILAJDIĆ Grga	LIKA
7	SAIDOV Saiddjafar	MDA
8	VOULGARIS Menelaos	GRE
9	PAPPAS Eleftherios	GRE
10	RIVALTA Noel	RAV
10	MEDI Tarik	MKD
10	DIZDAR Teo	ZGB

1 - Zlato

LIAKH Ivan
2 - Srebro

ADŽAGA Ivan
3 - Bronca

BOLANT Boris

VIDOVIĆ Valentino

Plasman	Ime	Ekipa	MT	MW	ML	CP	VF	VS	RS	TS	TG
1	LIAKH Ivan	UKR	4	4	0	17	1	3	0	0	0
2	ADŽAGA Ivan	PODR	3	2	1	8	0	2	0	0	0
3	BOLANT Boris	PIKV	3	2	1	10	2	0	0	0	0
3	VIDOVIĆ Valentino	PETR	4	3	1	13	0	3	0	0	0
5	ALIBALIĆ Ivano	BIH	2	0	2	0	0	0	0	0	0
5	FILAJDIĆ Grga	LIKA	3	1	2	5	1	0	0	0	0
7	SAIDOV Saiddjafar	MDA	2	1	1	5	0	1	0	0	0
8	VOULGARIS Menelaos	GRE	3	1	2	4	0	1	0	0	0
9	PAPPAS Eleftherios	GRE	1	0	1	1	0	0	0	0	0
10	RIVALTA Noel	RAV	1	0	1	0	0	0	0	0	0
10	MEDI Tarik	MKD	1	0	1	0	0	0	0	0	0
10	DIZDAR Teo	ZGB	1	0	1	0	0	0	0	0	0

MT - matches total, **MW** - matches won, **ML** - matches lost, **CP** - classification points, **VF** - match victories by fall, **VS** - match victories by superiority,
RS - round victories by superiority, **TS** - technical points scored, **TG** - technical points given



DETALJI BORBI

XXVII. Međunarodni Božićni turnir GR

MLDJ GR 59 kg

2	Q	GRE	VOULGARIS Menelaos	4	ST	0	0		
		MKD	MEDI Tarik	0		0	0		
3	Q	UKR	LIAKH Ivan	5	VT	0	0		
		LIKA	FILAJDIĆ Grga	0		0	0		
4	Q	GRE	PAPPAS Eleftherios	1	SP	0	0		
		MDA	SAIDOV Saiddjafar	4		0	0		
5	Q	PETR	VIDOVIĆ Valentino	4	ST	0	0		
		ZGB	DIZDAR Teo	0		0	0		
20	1/4 F	BIH	ALIBALIĆ Ivano	0	ST	0	0		
		PODR	ADŽAGA Ivan	4		0	0		
21	1/4 F	RAV	RIVALTA Noel	0	VT	0	0		
		PIKV	BOLANT Boris	5		0	0		
22	1/4 F	GRE	VOULGARIS Menelaos	0	ST	0	0		
		UKR	LIAKH Ivan	4		0	0		
23	1/4 F	MDA	SAIDOV Saiddjafar	1	SP	0	0		
		PETR	VIDOVIĆ Valentino	4		0	0		
37	1/2 F	PODR	ADŽAGA Ivan	4	ST	0	0		
		PIKV	BOLANT Boris	0		0	0		
38	1/2 F	UKR	LIAKH Ivan	4	SP	0	0		
		PETR	VIDOVIĆ Valentino	1		0	0		
50	RB1	LIKA	FILAJDIĆ Grga	5	VT	0	0		
		GRE	VOULGARIS Menelaos	0		0	0		
55	F 3-5	BIH	ALIBALIĆ Ivano	0	VT	0	0		
		PIKV	BOLANT Boris	5		0	0		
56	F 3-5	LIKA	FILAJDIĆ Grga	0	ST	0	0		
		PETR	VIDOVIĆ Valentino	4		0	0		
63	F 1-2	PODR	ADŽAGA Ivan	0	ST	0	0		
		UKR	LIAKH Ivan	4		0	0		



TECHNICAL POINTS SUMMARY

XXVII. Međunarodni Božićni turnir GR

MLDJ GR 59 kg

■ 1 point ■ 2 points ■ 4 points ■ 5 points

1.	LIAKH Ivan		UKR	0	(4m)
2.	ADŽAGA Ivan	·	PODR	0	(3m)
3.	BOLANT Boris	·	PIKV	0	(3m)
3.	VIDOVIĆ Valentino	·	PETR	0	(4m)
5.	ALIBALIĆ Ivano		BIH	0	(2m)
5.	FILAJDIĆ Grga	·	LIKA	0	(3m)
7.	SAIDOV Saiddjafar		MDA	0	(2m)
8.	VOULGARIS Menelaos		GRE	0	(3m)
9.	PAPPAS Eleftherios		GRE	0	(1m)
10.	RIVALTA Noel	·	RAV	0	(1m)
10.	MEDI Tarik		MKD	0	(1m)
10.	DIZDAR Teo	·	ZGB	0	(1m)

0 TOTAL POINTS 14 TOTAL MATCHES 0,0 POINTS PER MATCH



TABLICA ELIMINACIJE

XXVII. Međunarodni Božićni turnir GR

MLDJ GR 66 kg

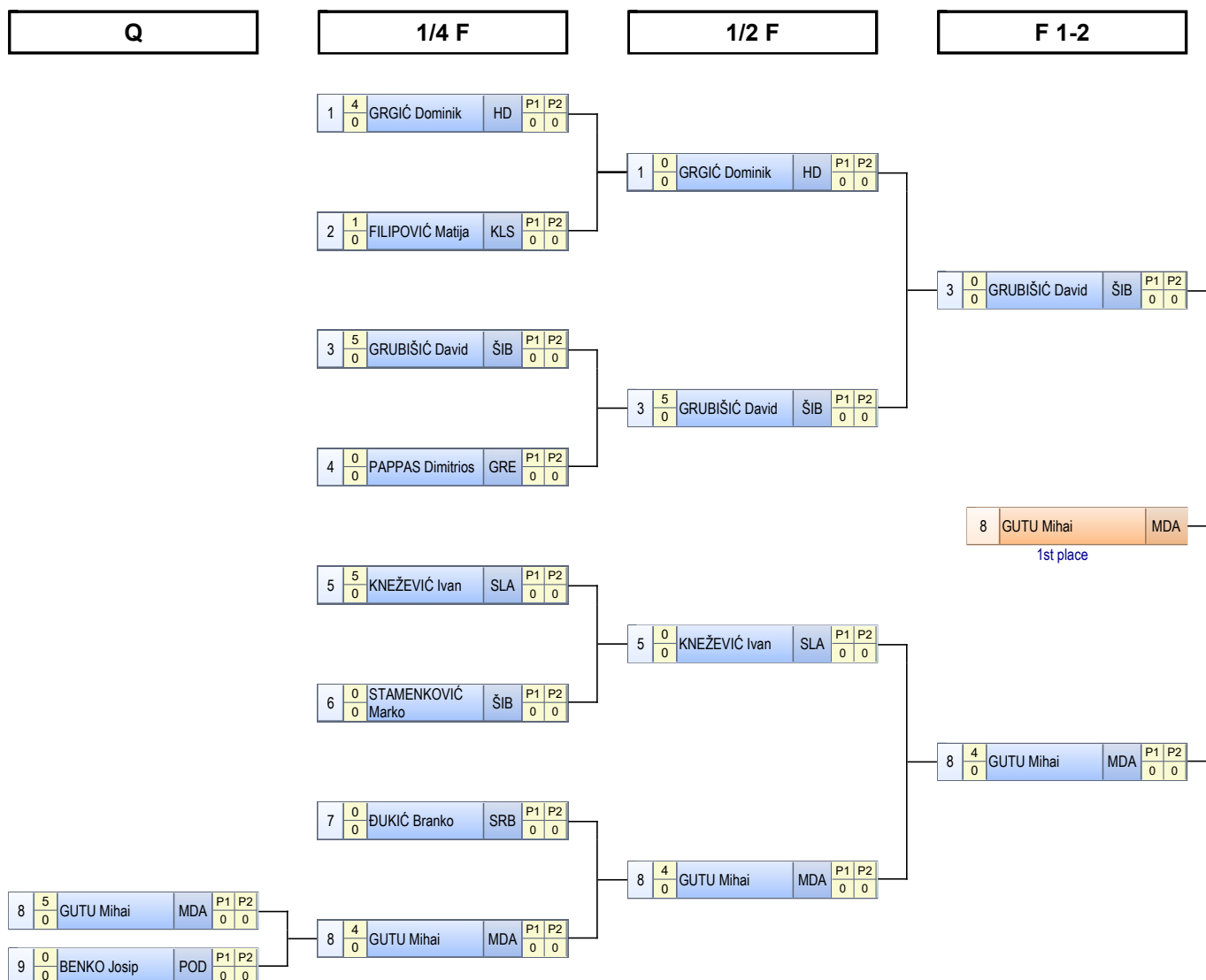

KONAČNI POREDAK

Plasman	Hrvač	Ekipa
1	GUTU Mihai	MDA
2	GRUBIŠIĆ David	ŠIB
3	GRGIĆ Dominik	HD
3	ĐUKIĆ Branko	SRB
5	PAPPAS Dimitrios	GRE
5	KNEŽEVIĆ Ivan	SLAT
7	FILIPOVIĆ Matija	KLS
7	BENKO Josip	PODR
9	STAMENKOVIĆ Marko	ŠIB

Repechage A

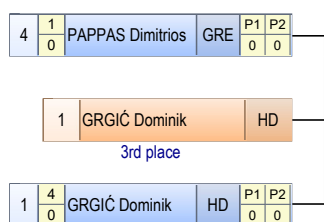

Repechage B

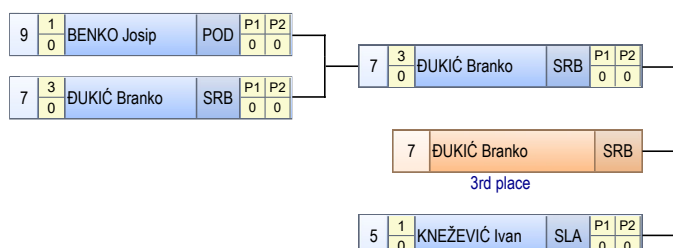

1 - Zlato

GUTU Mihai
2 - Srebro

GRUBIŠIĆ David
3 - Bronca

GRGIĆ Dominik

ĐUKIĆ Branko

Plasman	Ime	Ekipa	MT	MW	ML	CP	VF	VS	RS	TS	TG
1	GUTU Mihai	MDA	4	4	0	17	1	3	0	0	0
2	GRUBIŠIĆ David	ŠIB	3	2	1	10	2	0	0	0	0
3	GRGIĆ Dominik	HD	3	2	1	8	0	2	0	0	0
3	ĐUKIĆ Branko	SRB	3	2	1	6	0	0	0	0	0
5	PAPPAS Dimitrios	GRE	2	0	2	1	0	0	0	0	0
5	KNEŽEVIĆ Ivan	SLAT	3	1	2	6	1	0	0	0	0
7	FILIPOVIĆ Matija	KLS	1	0	1	1	0	0	0	0	0
7	BENKO Josip	PODR	2	0	2	1	0	0	0	0	0
9	STAMENKOVIĆ Marko	ŠIB	1	0	1	0	0	0	0	0	0

MT - matches total, **MW** - matches won, **ML** - matches lost, **CP** - classification points, **VF** - match victories by fall, **VS** - match victories by superiority,
RS - round victories by superiority, **TS** - technical points scored, **TG** - technical points given



DETALJI BORBI

XXVII. Međunarodni Božićni turnir GR

MLDJ GR 66 kg

9	Q	MDA	GUTU Mihai	5	VT	0	0		
		PODR	BENKO Josip	0		0	0		
27	1/4 F	HD	GRGIĆ Dominik	4	SP	0	0		
		KLS	FILIPOVIĆ Matija	1		0	0		
28	1/4 F	ŠIB	GRUBIŠIĆ David	5	VT	0	0		
		GRE	PAPPAS Dimitrios	0		0	0		
29	1/4 F	SLAT	KNEŽEVIĆ Ivan	5	VT	0	0		
		ŠIB	STAMENKOVIĆ Marko	0		0	0		
30	1/4 F	SRB	ĐUKIĆ Branko	0	ST	0	0		
		MDA	GUTU Mihai	4		0	0		
42	1/2 F	HD	GRGIĆ Dominik	0	VT	0	0		
		ŠIB	GRUBIŠIĆ David	5		0	0		
43	1/2 F	SLAT	KNEŽEVIĆ Ivan	0	ST	0	0		
		MDA	GUTU Mihai	4		0	0		
52	RB1	PODR	BENKO Josip	1	PP	0	0		
		SRB	ĐUKIĆ Branko	3		0	0		
57	F 3-5	GRE	PAPPAS Dimitrios	1	SP	0	0		
		HD	GRGIĆ Dominik	4		0	0		
58	F 3-5	SRB	ĐUKIĆ Branko	3	PP	0	0		
		SLAT	KNEŽEVIĆ Ivan	1		0	0		
65	F 1-2	ŠIB	GRUBIŠIĆ David	0	ST	0	0		
		MDA	GUTU Mihai	4		0	0		



TECHNICAL POINTS SUMMARY

XXVII. Međunarodni Božićni turnir GR

MLDJ GR 66 kg

■ 1 point

■ 2 points

■ 4 points

■ 5 points

1. GUTU Mihai		MDA	0 (4m)
2. GRUBIŠIĆ David	·	ŠIB	0 (3m)
3. GRGIĆ Dominik	·	HD	0 (3m)
3. ĐUKIĆ Branko		SRB	0 (3m)
5. PAPPAS Dimitrios		GRE	0 (2m)
5. KNEŽEVIĆ Ivan	·	SLAT	0 (3m)
7. FILIPOVIĆ Matija	·	KLS	0 (1m)
7. BENKO Josip	·	PODR	0 (2m)
9. STAMENKOVIĆ Marko	·	ŠIB	0 (1m)

0 TOTAL POINTS **11** TOTAL MATCHES **0,0** POINTS PER MATCH



TABLICA ELIMINACIJE

XXVII. Međunarodni Božićni turnir GR

MLDJ GR 73 kg

R.br.	Hrvač	Ekipa	1	2	3	4	PP	PL.
1	BARANOV Pavlo	UKRAINE		5	4	3	12	1.
3	RADIČEVIĆ Antonio	HRVATSKI DRAGO	0		4	4	8	2.
5	TRAGER Petar	LIKA	0	0		0	0	4.
7	IKIĆ Strahinja	SERBIA	1	1	4		6	3.

A N1

1	5/0	BARANOV Pavlo	UKR	P1	P2	0	0
3	0/0	RADIČEVIĆ Antonio	HD	P1	P2	0	0

5	0/0	TRAGER Petar	LIK	P1	P2	0	0
7	4/0	IKIĆ Strahinja	SRB	P1	P2	0	0

A N2

1	4/0	BARANOV Pavlo	UKR	P1	P2	0	0
5	0/0	TRAGER Petar	LIK	P1	P2	0	0

3	4/0	RADIČEVIĆ Antonio	HD	P1	P2	0	0
7	1/0	IKIĆ Strahinja	SRB	P1	P2	0	0

A N3

1	3/0	BARANOV Pavlo	UKR	P1	P2	0	0
7	1/0	IKIĆ Strahinja	SRB	P1	P2	0	0

3	4/0	RADIČEVIĆ Antonio	HD	P1	P2	0	0
5	0/0	TRAGER Petar	LIK	P1	P2	0	0

R.br.	Hrvač	Ekipa	1	2	3	PP	PL.
2	POHLODEK Daniel	CZECH REPUBLIC		1	5	6	2.
4	STRIKA Roko	ZADAR	4		5	9	1.
6	DRAŠKOVIĆ Luka	MONTENEGRO	0	0		0	3.

B N1

2	1/0	POHLODEK Daniel	CZE	P1	P2	0	0
4	4/0	STRIKA Roko	ZD	P1	P2	0	0

B N2

6	0/0	DRAŠKOVIĆ Luka	MNE	P1	P2	0	0
2	5/0	POHLODEK Daniel	CZE	P1	P2	0	0

B N3

4	5/0	STRIKA Roko	ZD	P1	P2	0	0
6	0/0	DRAŠKOVIĆ Luka	MNE	P1	P2	0	0

1/2F

1	5/0	BARANOV Pavlo	UKR	P1	P2	0	0
2	0/0	POHLODEK Daniel	CZE	P1	P2	0	0
4	5/0	STRIKA Roko	ZD	P1	P2	0	0
3	0/0	RADIČEVIĆ Antonio	HD	P1	P2	0	0

F 1-2

1	1/0	BARANOV Pavlo	UKR	P1	P2	0	0
4	4/0	STRIKA Roko	ZD	P1	P2	0	0
4	3/0	STRIKA Roko	ZD	P1	P2	0	0

1st place

F 3-4

2	5/0	POHLODEK Daniel	CZE	P1	P2	0	0
2	0/0	POHLODEK Daniel	CZE	P1	P2	0	0
3	0/0	RADIČEVIĆ Antonio	HD	P1	P2	0	0

3rd place

KONAČNI POREDAK

Plasman	Hrvač	Ekipa
1	STRIKA Roko	ZD
2	BARANOV Pavlo	UKR
3	POHLODEK Daniel	CZE
4	RADIČEVIĆ Antonio	HD
5	IKIĆ Strahinja	SRB
6	TRAGER Petar	LIKA
7	DRAŠKOVIĆ Luka	MNE



POREDAK

XXVII. Međunarodni Božićni turnir GR

MLDJ GR 73 kg

1 - Zlato



STRIKA Roko

2 - Srebro



BARANOV Pavlo

3 - Bronca



POHLODEK Daniel



Plasman	Ime	Ekipa	MT	MW	ML	CP	VF	VS	RS	TS	TG
1	STRIKA Roko	ZD	4	4	0	17	2	1	0	0	0
2	BARANOV Pavlo	UKR	5	4	1	18	2	1	0	0	0
3	POHLODEK Daniel	CZE	4	2	2	11	2	0	0	0	0
4	RADIČEVIĆ Antonio	HD	5	2	3	8	0	2	0	0	0
5	IKIĆ Strahinja	SRB	3	1	2	6	0	1	0	0	0
6	TRAGER Petar	LIKA	3	0	3	0	0	0	0	0	0
7	DRAŠKOVIĆ Luka	MNE	2	0	2	0	0	0	0	0	0

MT - matches total, MW - matches won, ML - matches lost, CP - classification points, VF - match victories by fall, VS - match victories by superiority, RS - round victories by superiority, TS - technical points scored, TG - technical points given



DETALJI BORBI

XXVII. Međunarodni Božićni turnir GR

MLDJ GR 73 kg

6	A N1	UKR	BARANOV Pavlo	5	VT	0	0		
		HD	RADIČEVIĆ Antonio	0		0	0		
7	A N1	LIKA	TRAGER Petar	0	ST	0	0		
		SRB	IKIĆ Strahinja	4		0	0		
8	B N1	CZE	POHLODEK Daniel	1	SP	0	0		
		ZD	STRIKA Roko	4		0	0		
24	A N2	UKR	BARANOV Pavlo	4	ST	0	0		
		LIKA	TRAGER Petar	0		0	0		
25	A N2	HD	RADIČEVIĆ Antonio	4	SP	0	0		
		SRB	IKIĆ Strahinja	1		0	0		
26	B N2	MNE	DRAŠKOVIĆ Luka	0	VT	0	0		
		CZE	POHLODEK Daniel	5		0	0		
39	A N3	UKR	BARANOV Pavlo	3	PP	0	0		
		SRB	IKIĆ Strahinja	1		0	0		
40	A N3	HD	RADIČEVIĆ Antonio	4	ST	0	0		
		LIKA	TRAGER Petar	0		0	0		
41	B N3	ZD	STRIKA Roko	5	VT	0	0		
		MNE	DRAŠKOVIĆ Luka	0		0	0		
48	1/2F	UKR	BARANOV Pavlo	5	VT	0	0		
		CZE	POHLODEK Daniel	0		0	0		
49	1/2F	ZD	STRIKA Roko	5	VT	0	0		
		HD	RADIČEVIĆ Antonio	0		0	0		
51	F 3-4	CZE	POHLODEK Daniel	5	VT	0	0		
		HD	RADIČEVIĆ Antonio	0		0	0		
64	F 1-2	UKR	BARANOV Pavlo	1	PP	0	0		
		ZD	STRIKA Roko	3		0	0		



TECHNICAL POINTS SUMMARY

XXVII. Međunarodni Božićni turnir GR

MLDJ GR 73 kg

■ 1 point ■ 2 points ■ 4 points ■ 5 points

1. STRIKA Roko	ZD	0 (4m)
2. BARANOV Pavlo	 UKR	0 (5m)
3. POHLODEK Daniel	 CZE	0 (4m)
4. RADIČEVIĆ Antonio	HD	0 (5m)
5. IKIĆ Strahinja	 SRB	0 (3m)
6. TRAGER Petar	LIKA	0 (3m)
7. DRAŠKOVIĆ Luka	 MNE	0 (2m)

0 TOTAL POINTS 13 TOTAL MATCHES 0,0 POINTS PER MATCH



TABLICA ELIMINACIJE

XXVII. Međunarodni Božićni turnir GR

MLDJ GR 85 kg

R.br.	Hrvač	Ekipa	1	2	3	PP	PL.
1	SZABO Balint	HUNGARY		4	1	5	2.
2	TOLIĆ Filip	PETRINJA	0		0	0	3.
3	VUDRAG Mate	ŠIBENIK	3	4		7	1.

N1

1	4 0	SZABO Balint	HUN	P1 0	P2 0
2	0 0	TOLIĆ Filip	PET	P1 0	P2 0

N2

3	3 0	VUDRAG Mate	ŠIB	P1 0	P2 0
1	1 0	SZABO Balint	HUN	P1 0	P2 0

N3

2	0 0	TOLIĆ Filip	PET	P1 0	P2 0
3	4 0	VUDRAG Mate	ŠIB	P1 0	P2 0

KONAČNI POREDAK

Plasman	Hrvač	Ekipa
1	VUDRAG Mate	ŠIB
2	SZABO Balint	HUN
3	TOLIĆ Filip	PETR

1 - Zlato



VUDRAG Mate

2 - Srebro



SZABO Balint

3 - Bronca



TOLIĆ Filip



Plasman	Ime	Ekipa	MT	MW	ML	CP	VF	VS	RS	TS	TG
1	VUDRAG Mate	ŠIB	2	2	0	7	0	1	0	0	0
2	SZABO Balint	HUN	2	1	1	5	0	1	0	0	0
3	TOLIĆ Filip	PETR	2	0	2	0	0	0	0	0	0

MT - matches total, MW - matches won, ML - matches lost, CP - classification points, VF - match victories by fall, VS - match victories by superiority, RS - round victories by superiority, TS - technical points scored, TG - technical points given



DETALJI BORBI

XXVII. Međunarodni Božićni turnir GR

MLDJ GR 85 kg

11	N1	HUN	SZABO Balint	4	ST	0	0		
		PETR	TOLIĆ Filip	0		0	0		
32	N2	ŠIB	VUDRAG Mate	3	PP	0	0		
		HUN	SZABO Balint	1		0	0		
45	N3	PETR	TOLIĆ Filip	0	ST	0	0		
		ŠIB	VUDRAG Mate	4		0	0		



TECHNICAL POINTS SUMMARY

XXVII. Međunarodni Božićni turnir GR

MLDJ GR 85 kg

■ 1 point

■ 2 points

■ 4 points

■ 5 points

1. VUDRAG Mate	·	ŠIB	0 (2m)
2. SZABO Balint		HUN	0 (2m)
3. TOLIĆ Filip	·	PETR	0 (2m)

0 TOTAL POINTS

3 TOTAL MATCHES

0,0 POINTS PER MATCH



EKIPNI POREDAK

XXVII. Međunarodni Božićni turnir GR

MLDJ GR

Place	Team	32 kg	35 kg	38 kg	42 kg	47 kg	53 kg	59 kg	66 kg	73 kg	85 kg	TOTAL
1	HUN			40		39	31				20	130
2	UKR	20		10	15	20		25		20		110
3	ROU	25	20	30		15						90
4	SRB		25		14	16			15	10		80
5	SWE			15	15	15	8					53
6	GRE			2	16		15	10	10			53
7	ŠIB								24		25	49
8	LIKA				25		2	10		9		46
9	PODR				4	8		20	8			40
10	SLAT	15		4	10				10			39
11	PETR			8				15			15	38
12	MDA							8	25			33
13	HD								15	12		27
14	SIS				20		6					26
15	ZD									25		25
16	ZGB				4	4	15	2				25
17	GS						20					20
18	CZE									15		15
18	PIKV							15				15
18	VG		15									15
21	BIH							10				10
21	MET						10					10
21	VIND						10					10
24	KLS								8			8
24	LUDB			8								8
24	MNE									8		8
27	SKR					4						4
28	MKD			2				2				4
29	RAV							2				2
30	POR											0
30	SES											0
30	TREŠ											0

**BOSNIA AND HERZEGOVINA (BIH)****Wrestler / Lutteur**

65 kg	MEMIŠEVIĆ, Namik
71 kg	DAVIDOVIĆ, Neven

BULGARIA (BUL)**Wrestler / Lutteur**

45 kg	EMILOV, Miroslav
-------	------------------

CROATIA (CRO)**Wrestler / Lutteur**

45 kg	OSMANOVIĆ, Renato
48 kg	REBIĆ, Matej
51 kg	PALATINUŠ, Ivan
51 kg	ČABULA, Bruno
55 kg	KNEŽEVIĆ, Domagoj
55 kg	IVANČIĆ, Luka
60 kg	CELIČEK, Domagoj
60 kg	DJOK, Dominik
60 kg	HADER, Josip
65 kg	BOŠNJAK, Kristijan
71 kg	VUKAS, Marko
71 kg	SALAJEC, Mihael
71 kg	DJOK, Emanuel
80 kg	ŠTURLIĆ, Zvonimir
80 kg	BERBEROVIĆ, Nermin
92 kg	BRKAN, Tomislav
110 kg	BUBIČIĆ, Andrej

CZECH REPUBLIC (CZE)**Wrestler / Lutteur**

45 kg	MAGOMEDOV, Dalgat
65 kg	ŠVIGLER, Ivo
80 kg	HAVELKA, Ondrej
110 kg	VACHUDA, Lukaš

GOSPIĆ (GS)**Wrestler / Lutteur**



LISTA SUDIONIKA

XXVII. Međunarodni Božićni turnir GR

KAD GR

45 kg RADOŠEVIĆ, Frane
55 kg PETRANOVIĆ, Robert

GREECE (GRE)

Wrestler / Lutteur

45 kg ATHANASTADIS, Theodorosž
45 kg LIAKOULIS, Dimitrios
55 kg PAPAGEORGIOU, Georgios
60 kg PETKOS, Ionnis
60 kg MICHAILIDIS, Georgios
71 kg ANASTASIAIDIS, Theocharis
71 kg CHARITIDIS, Eleftherios
71 kg VASILAKOPOULOS, Andreas
92 kg KOUZILOS, Georgios

HERKUL (HER)

Wrestler / Lutteur

51 kg PEPIĆ, Marin
60 kg KAMENJAŠEVIĆ, Niko
71 kg NIKOLIĆ, Marko
71 kg ŠARKO, Matija

HRVATSKI DRAGOVOLJAC (HD)

Wrestler / Lutteur

110 kg ČANIĆ, Lovro

HUNGARY (HUN)

Wrestler / Lutteur

45 kg RAFAEL, Daniel
51 kg SIMON, Mate
51 kg BABYNETS, Maksym
51 kg VITEK, Amadeusz
55 kg KOVACS, Gabor
55 kg MOLNAR, Tibor
55 kg MOLNAR, Csaba
55 kg MAROSZI, Krisztian
55 kg SZAKCSI, Rajmund Istvan
65 kg SEBOK, Kristof
71 kg KOVACS, Gergely
71 kg GAL, Bence



LISTA SUDIONIKA

XXVII. Međunarodni Božićni turnir GR

KAD GR

80 kg	KISBERDO, Balasz
80 kg	PAPP, Barnabas
92 kg	VARSANYI, Laszlo
110 kg	RADAK, Bertalan

ITALY (ITA)

Wrestler / Lutteur

60 kg	MANCHIA, Massimo
65 kg	BUZZI, Mattia
65 kg	BOSI, Tommaso
65 kg	FRONTALI, Giuseppe
65 kg	ROMANO, Alessandro
71 kg	MERCATALI, Marco

LIKA (LIKA)

Wrestler / Lutteur

51 kg	KALANJ, Dominik
55 kg	TOMIĆ, Lukas
71 kg	STRMOTA, Lovre
110 kg	JAŠAREVSKI, Karlo

LOKOMOTIVA (LOK)

Wrestler / Lutteur

45 kg	DJURIĆ, Nikola
-------	----------------

LUDBREG (LUDB)

Wrestler / Lutteur

60 kg	PETRIĆ, Leo
-------	-------------

METALAC (MET)

Wrestler / Lutteur

60 kg	MIKEC, Luka
65 kg	ZURAK, Lovro
92 kg	VITKO, Ivan

MOLDOVA (MDA)

Wrestler / Lutteur



LISTA SUDIONIKA

XXVII. Međunarodni Božićni turnir GR

KAD GR

45 kg	BAJURA, Oleg
45 kg	PANIS, Alexandru
45 kg	DENISENCO, Pavel
48 kg	TALMAZAN, Mihail
48 kg	MARLEAN, Danila
51 kg	ERIOMENCO, Vitalie
55 kg	STOIANOV, Stanislav
55 kg	UNCIUC, Cristian
65 kg	FLOREA, Nichita
65 kg	HAHLOVSCI, Alexei
65 kg	SOLOVEI, Alexandru
71 kg	RUSU, Catalin
71 kg	VOLOSCIUC, Iulian
80 kg	ROTARI, Danil
80 kg	CERNOVOL, Ilia
92 kg	COVALI, Rostislav

MONTENEGRO (MNE)

Wrestler / Lutteur

60 kg	BURZANOVIĆ, Aleksandar
-------	------------------------

PETRINJA (PETR)

Wrestler / Lutteur

60 kg	HLATKI, David
-------	---------------

PIK VRBOVEC (PIKV)

Wrestler / Lutteur

92 kg	KLEPEC, Ivan
-------	--------------

RAVENNA (RAV)

Wrestler / Lutteur

71 kg	RIVALTA, Leon
-------	---------------

ROMANIA (ROU)

Wrestler / Lutteur

45 kg	LUNGU, Iulian-Vasile
51 kg	MIHAI, Denis
60 kg	DRAGOI, Emil-Mihai

**SERBIA (SRB)****Wrestler / Lutteur**

45 kg	KIRILOV, Borislav
48 kg	KALOYANOV, Krasimir
48 kg	VUČKOVIĆ, Luka
51 kg	RADULOVIĆ, Radovan
55 kg	LEČIĆ, Uroš
55 kg	PEROVIĆ, Miloš
55 kg	KARAPANDŽA, Nikola
60 kg	DIMITROV, Radoslav
65 kg	KIMOSKI, Nemanja
65 kg	DIMITROV, Radoslav
65 kg	VASILEV, Vitorio
71 kg	MIHAJLOVIĆ, Andrija
71 kg	VASILEV, Vitorio
80 kg	MOLNAR, David
80 kg	PAVLICA, Jovan

SESVETE (SES)**Wrestler / Lutteur**

92 kg	MUJAKIĆ, Leonardo
-------	-------------------

SESVETSKI KRALJEVEC (SKR)**Wrestler / Lutteur**

65 kg	ŠIMUNKOVIĆ, Nikola
-------	--------------------

SLATINA (SLAT)**Wrestler / Lutteur**

45 kg	GARDILO, Ivan
51 kg	MINAUF, Antonio

SLOVENIA (SLO)**Wrestler / Lutteur**

71 kg	ŽAN, Perko
-------	------------

SPLIT (ST)



LISTA SUDIONIKA

XXVII. Međunarodni Božićni turnir GR

KAD GR

Wrestler / Lutteur

65 kg BLAŽEVIĆ, Josip

SWEDEN (SWE)

Wrestler / Lutteur

48 kg GUSTAFSSON, William
51 kg AYHAN, Ilias
51 kg GRAVIN, Lars
55 kg KARLSSON, Hugo
60 kg OBERG, Linus
60 kg CHJAN, Denny
65 kg BARBANOS, Georgios
71 kg FOUGHANI, Leo
80 kg JOHANSSON, Alexander
80 kg SERTCANLI, Hamza

ŠIBENIK (ŠIB)

Wrestler / Lutteur

65 kg IVANOVIĆ, Tomislav
71 kg BUŠAC, Filip

UKRAINE (UKR)

Wrestler / Lutteur

45 kg SHEVCUK, Oleksandr
51 kg MYSHANCH, Vasil
60 kg CHMYR, Ivan
60 kg POPADYNETS, Roman
65 kg KHUTKO, Artem
80 kg YASHKIN, Kyrylo
92 kg POILYVKO, Vladyslav

VELIKA GORICA 1991 (VG)

Wrestler / Lutteur

51 kg ANDABAKA, Marko

VINDIJA (VIND)

Wrestler / Lutteur

55 kg FAJFARIĆ, Luka



LISTA SUDIONIKA

XXVII. Međunarodni Božićni turnir GR

KAD GR

71 kg	KELEMENIĆ, Edi
80 kg	FLORIJANIĆ, Ivica
80 kg	BEDEKOVIĆ, Ivan

ZADAR (ZD)

Wrestler / Lutteur

71 kg	BUŠLJETA, Renato
-------	------------------

Ekipe

	BOSNIA AND HERZEGOVINA	BIH
	BULGARIA	BUL
	CROATIA	CRO
	CZECH REPUBLIC	CZE
	GOSPIĆ	GS
	GREECE	GRE
	HERKUL	HER
	HRVATSKI DRAGOVOLJAC	HD
	HUNGARY	HUN
	ITALY	ITA
	LIKA	LIKA
	LOKOMOTIVA	LOK
	LUDBREG	LUDB
	METALAC	MET
	MOLDOVA	MDA
	MONTENEGRO	MNE
	PETRINJA	PETR
	PIK VRBOVEC	PIKV
	RAVENNA	RAV
	ROMANIA	ROU
	SERBIA	SRB
	SESVETE	SES
	SESVETSKI KRALJEVEC	SKR
	SLATINA	SLAT
	SLOVENIA	SLO
	SPLIT	ST
	SWEDEN	SWE
	ŠIBENIK	ŠIB
	UKRAINE	UKR
	VELIKA GORICA 1991	VG
	VINDIJA	VIND
	ZADAR	ZD

Broj ekipa

32



BROJ NATJECATELJA PO EKIPI

XXVII. Međunarodni Božićni turnir GR

KAD GR

Ekipa	45 kg	48 kg	51 kg	55 kg	60 kg	65 kg	71 kg	80 kg	92 kg	110 kg	UKUPNO
BIH						1	1				2
BUL	1										1
CRO	1	1	2	2	3	1	3	2	1	1	17
CZE	1					1		1		1	4
GS	1			1							2
GRE	2			1	2		3		1		9
HER			1		1		2				4
HD										1	1
HUN	1		3	5		1	2	2	1	1	16
ITA					1	4	1				6
LIKA			1	1			1			1	4
LOK	1										1
LADB					1						1
MET					1	1			1		3
MDA	3	2	1	2		3	2	2	1		16
MNE					1						1
PETR					1						1
PIKV									1		1
RAV							1				1
ROU	1		1		1						3
SRB	1	2	1	3	1	3	2	2			15
SES									1		1
SKR						1					1
SLAT	1		1								2
SLO							1				1
ST						1					1
SWE		1	2	1	2	1	1	2			10
ŠIB						1	1				2
UKR	1		1		2	1		1	1		7
VG			1								1
VIND				1			1	2			4
ZD							1				1
UKUPNO	15	6	15	17	17	20	23	14	8	5	140

Broj ekipa



TABLICA ELIMINACIJE

XXVII. Međunarodni Božićni turnir GR

KAD GR 45 kg

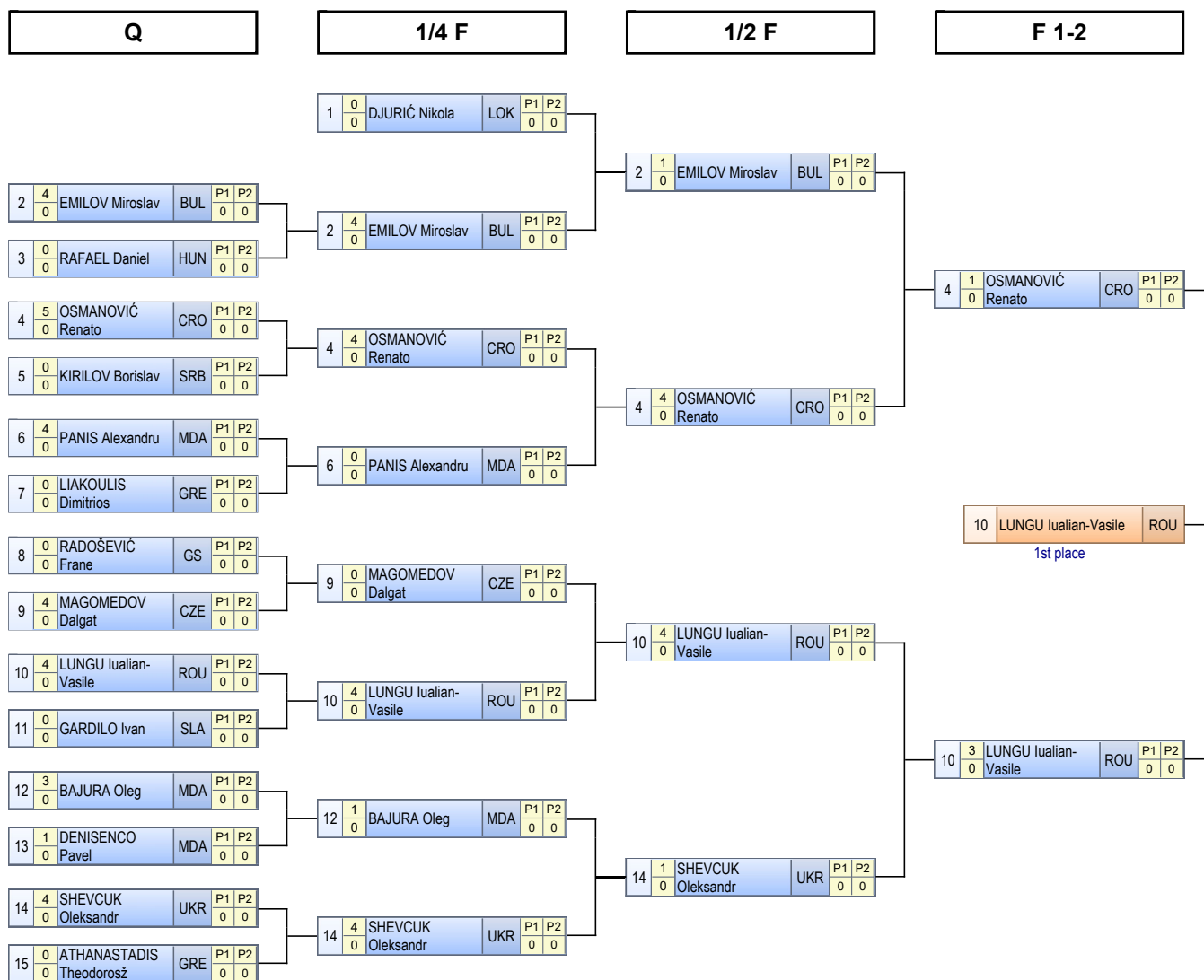

KONAČNI POREDAK

Plasman	Hrvač	Ekipa
1	LUNGU Iulian-Vasile	ROU
2	OSMANOVIĆ Renato	CRO
3	EMILOV Miroslav	BUL
3	SHEVCIUK Oleksandr	UKR
5	KIRILOV Borislav	SRB
5	GARDILO Ivan	SLAT
7	PANIS Alexandru	MDA
7	MAGOMEDOV Dalgat	CZE
9	BAJURA Oleg	MDA
10	DENISENCO Pavel	MDA
11	DJURIĆ Nikola	LOK
11	RAFAEL Daniel	HUN
11	LIAKOULIS Dimitrios	GRE
11	RADOŠEVIĆ Frane	GS
11	ATHANASTADIS Theodorosž	GRE

Repechage A

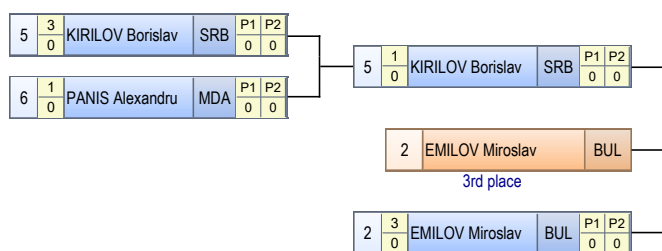

Repechage B

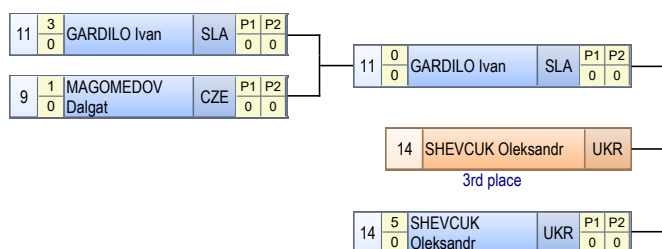

1 - Zlato

LUNGU Iualian-Vasile
2 - Srebro

OSMANOVIĆ Renato
3 - Bronca

EMILOV Miroslav

SHEVCUK Oleksandr

Plasman	Ime	Ekipa	MT	MW	ML	CP	VF	VS	RS	TS	TG
1	LUNGU Iualian-Vasile	ROU	4	4	0	15	0	3	0	0	0
2	OSMANOVIĆ Renato	CRO	4	3	1	14	1	2	0	0	0
3	EMILOV Miroslav	BUL	4	3	1	12	0	2	0	0	0
3	SHEVCUK Oleksandr	UKR	4	3	1	14	1	2	0	0	0
5	KIRILOV Borislav	SRB	3	1	2	4	0	0	0	0	0
5	GARDILO Ivan	SLAT	3	1	2	3	0	0	0	0	0
7	PANIS Alexandru	MDA	3	1	2	5	0	1	0	0	0
7	MAGOMEDOV Dalgat	CZE	3	1	2	5	0	1	0	0	0
9	BAJURA Oleg	MDA	2	1	1	4	0	0	0	0	0
10	DENISENCO Pavel	MDA	1	0	1	1	0	0	0	0	0
11	DJURIĆ Nikola	LOK	1	0	1	0	0	0	0	0	0
11	RAFAEL Daniel	HUN	1	0	1	0	0	0	0	0	0
11	LIAKOULIS Dimitrios	GRE	1	0	1	0	0	0	0	0	0
11	RADOŠEVIĆ Frane	GS	1	0	1	0	0	0	0	0	0
11	ATHANASTADIS Theodorosž	GRE	1	0	1	0	0	0	0	0	0

MT - matches total, MW - matches won, ML - matches lost, CP - classification points, VF - match victories by fall, VS - match victories by superiority, RS - round victories by superiority, TS - technical points scored, TG - technical points given



DETALJI BORBI

XXVII. Međunarodni Božićni turnir GR

KAD GR 45 kg

193	Q	BUL	EMILOV Miroslav	4	ST	0	0		
		HUN	RAFAEL Daniel	0		0	0		
194	Q	CRO	OSMANOVIĆ Renato	5	VT	0	0		
		SRB	KIRILOV Borislav	0		0	0		
195	Q	MDA	PANIS Alexandru	4	ST	0	0		
		GRE	LIAKOULIS Dimitrios	0		0	0		
196	Q	GS	RADOŠEVIĆ Frane	0	ST	0	0		
		CZE	MAGOMEDOV Dalgat	4		0	0		
197	Q	ROU	LUNGU Iulian-Vasile	4	ST	0	0		
		SLAT	GARDILO Ivan	0		0	0		
198	Q	MDA	BAJURA Oleg	3	PP	0	0		
		MDA	DENISENCO Pavel	1		0	0		
199	Q	UKR	SHEVCUK Oleksandr	4	ST	0	0		
		GRE	ATHANASTADIS Theodoros	0		0	0		
212	1/4 F	LOK	DJURIĆ Nikola	0	ST	0	0		
		BUL	EMILOV Miroslav	4		0	0		
213	1/4 F	CRO	OSMANOVIĆ Renato	4	ST	0	0		
		MDA	PANIS Alexandru	0		0	0		
214	1/4 F	CZE	MAGOMEDOV Dalgat	0	ST	0	0		
		ROU	LUNGU Iulian-Vasile	4		0	0		
215	1/4 F	MDA	BAJURA Oleg	1	SP	0	0		
		UKR	SHEVCUK Oleksandr	4		0	0		
222	1/2 F	BUL	EMILOV Miroslav	1	SP	0	0		
		CRO	OSMANOVIĆ Renato	4		0	0		
223	1/2 F	ROU	LUNGU Iulian-Vasile	4	SP	0	0		
		UKR	SHEVCUK Oleksandr	1		0	0		
228	RB1	SLAT	GARDILO Ivan	3	PP	0	0		
		CZE	MAGOMEDOV Dalgat	1		0	0		
229	RA1	SRB	KIRILOV Borislav	3	PP	0	0		
		MDA	PANIS Alexandru	1		0	0		
234	F 3-5	SLAT	GARDILO Ivan	0	VT	0	0		
		UKR	SHEVCUK Oleksandr	5		0	0		
235	F 3-5	SRB	KIRILOV Borislav	1	PP	0	0		
		BUL	EMILOV Miroslav	3		0	0		
241	F 1-2	CRO	OSMANOVIĆ Renato	1	PP	0	0		
		ROU	LUNGU Iulian-Vasile	3		0	0		



TECHNICAL POINTS SUMMARY

XXVII. Međunarodni Božićni turnir GR

KAD GR 45 kg

■ 1 point ■ 2 points ■ 4 points ■ 5 points

1.	LUNGU Iulian-Vasile	 ROU	0 (4m)
2.	OSMANOVIĆ Renato	 CRO	0 (4m)
3.	EMILOV Miroslav	 BUL	0 (4m)
3.	SHEVCUK Oleksandr	 UKR	0 (4m)
5.	KIRILOV Borislav	 SRB	0 (3m)
5.	GARDILO Ivan	· SLAT	0 (3m)
7.	PANIS Alexandru	 MDA	0 (3m)
7.	MAGOMEDOV Dalgat	 CZE	0 (3m)
9.	BAJURA Oleg	 MDA	0 (2m)
10.	DENISENCO Pavel	 MDA	0 (1m)
11.	DJURIĆ Nikola	· LOK	0 (1m)
11.	RAFAEL Daniel	 HUN	0 (1m)
11.	LIAKOULIS Dimitrios	 GRE	0 (1m)
11.	RADOŠEVIĆ Frane	· GS	0 (1m)
11.	ATHANASTADIS Theodorosž	 GRE	0 (1m)

0 TOTAL POINTS 18 TOTAL MATCHES 0,0 POINTS PER MATCH



TABLICA ELIMINACIJE

XXVII. Međunarodni Božićni turnir GR

KAD GR 48 kg

R.br.	Hrvač	Ekipa	1	2	3	PP	PL.
1	REBIĆ Matej	CROATIA		1	1	2	3.
3	MARLEAN Danila	MOLDOVA	3		3	6	1.
5	TALMAZAN Mihail	MOLDOVA	3	1		4	2.

A N1

1	1	REBIĆ Matej	CRO	P1	P2	0	0
3	3	MARLEAN Danila	MDA	P1	P2	0	0

A N2

5	3	TALMAZAN Mihail	MDA	P1	P2	0	0
1	1	REBIĆ Matej	CRO	P1	P2	0	0

A N3

3	3	MARLEAN Danila	MDA	P1	P2	0	0
5	1	TALMAZAN Mihail	MDA	P1	P2	0	0

R.br.	Hrvač	Ekipa	1	2	3	PP	PL.
2	VUČKOVIĆ Luka	SERBIA		0	0	0	3.
4	GUSTAFSSON William	SWEDEN	4		3	7	1.
6	KALOYANOV Krasimir	SERBIA	4	1		5	2.

B N1

2	0	VUČKOVIĆ Luka	SRB	P1	P2	0	0
4	4	GUSTAFSSON William	SWE	P1	P2	0	0

B N2

6	4	KALOYANOV Krasimir	SRB	P1	P2	0	0
2	0	VUČKOVIĆ Luka	SRB	P1	P2	0	0

B N3

4	3	GUSTAFSSON William	SWE	P1	P2	0	0
6	1	KALOYANOV Krasimir	SRB	P1	P2	0	0

1/2F

3	1	MARLEAN Danila	MDA	P1	P2	0	0
6	3	KALOYANOV Krasimir	SRB	P1	P2	0	0
4	4	GUSTAFSSON William	SWE	P1	P2	0	0
5	0	TALMAZAN Mihail	MDA	P1	P2	0	0

F 1-2

6	1	KALOYANOV Krasimir	SRB	P1	P2	0	0
4	4	GUSTAFSSON William	SWE	1st place			
4	3	GUSTAFSSON William	SWE	P1	P2	0	0

F 3-4

3	4	MARLEAN Danila	MDA	P1	P2	0	0
3	3	MARLEAN Danila	MDA	3rd place			
5	0	TALMAZAN Mihail	MDA	P1	P2	0	0

KONAČNI POREDAK

Plasman	Hrvač	Ekipa
1	GUSTAFSSON William	SWE
2	KALOYANOV Krasimir	SRB
3	MARLEAN Danila	MDA
4	TALMAZAN Mihail	MDA
5	VUČKOVIĆ Luka	SRB
6	REBIĆ Matej	CRO

1 - Zlato



GUSTAFSSON William

2 - Srebro



KALOYANOV Krasimir

3 - Bronca



MARLEAN Danila



Plasman	Ime	Ekipa	MT	MW	ML	CP	VF	VS	RS	TS	TG
1	GUSTAFSSON William	SWE	4	4	0	14	0	2	0	0	0
2	KALOYANOV Krasimir	SRB	4	2	2	9	0	1	0	0	0
3	MARLEAN Danila	MDA	4	3	1	11	0	1	0	0	0
4	TALMAZAN Mihail	MDA	4	1	3	4	0	0	0	0	0
5	VUČKOVIĆ Luka	SRB	2	0	2	0	0	0	0	0	0
6	REBIĆ Matej	CRO	2	0	2	2	0	0	0	0	0

MT - matches total, MW - matches won, ML - matches lost, CP - classification points, VF - match victories by fall, VS - match victories by superiority, RS - round victories by superiority, TS - technical points scored, TG - technical points given



DETALJI BORBI

XXVII. Međunarodni Božićni turnir GR

KAD GR 48 kg

253	A N1	CRO	REBIĆ Matej	1	PP	0	0		
		MDA	MARLEAN Danila	3		0	0		
254	B N1	SRB	VUČKOVIĆ Luka	0	ST	0	0		
		SWE	GUSTAFSSON William	4		0	0		
271	A N2	MDA	TALMAZAN Mihail	3	PP	0	0		
		CRO	REBIĆ Matej	1		0	0		
272	B N2	SRB	KALOYANOV Krasimir	4	ST	0	0		
		SRB	VUČKOVIĆ Luka	0		0	0		
281	A N3	MDA	MARLEAN Danila	3	PP	0	0		
		MDA	TALMAZAN Mihail	1		0	0		
282	B N3	SWE	GUSTAFSSON William	3	PP	0	0		
		SRB	KALOYANOV Krasimir	1		0	0		
287	1/2F	MDA	MARLEAN Danila	1	PP	0	0		
		SRB	KALOYANOV Krasimir	3		0	0		
288	1/2F	SWE	GUSTAFSSON William	4	ST	0	0		
		MDA	TALMAZAN Mihail	0		0	0		
289	F 3-4	MDA	MARLEAN Danila	4	ST	0	0		
		MDA	TALMAZAN Mihail	0		0	0		
302	F 1-2	SRB	KALOYANOV Krasimir	1	PP	0	0		
		SWE	GUSTAFSSON William	3		0	0		



TECHNICAL POINTS SUMMARY

XXVII. Međunarodni Božićni turnir GR

KAD GR 48 kg

■ 1 point ■ 2 points ■ 4 points ■ 5 points

1.	GUSTAFSSON William		SWE	0	(4m)
2.	KALOYANOV Krasimir		SRB	0	(4m)
3.	MARLEAN Danila		MDA	0	(4m)
4.	TALMAZAN Mihail		MDA	0	(4m)
5.	VUČKOVIĆ Luka		SRB	0	(2m)
6.	REBIĆ Matej		CRO	0	(2m)

0 TOTAL POINTS 10 TOTAL MATCHES 0,0 POINTS PER MATCH



TABLICA ELIMINACIJE

XXVII. Međunarodni Božićni turnir GR

KAD GR 51 kg

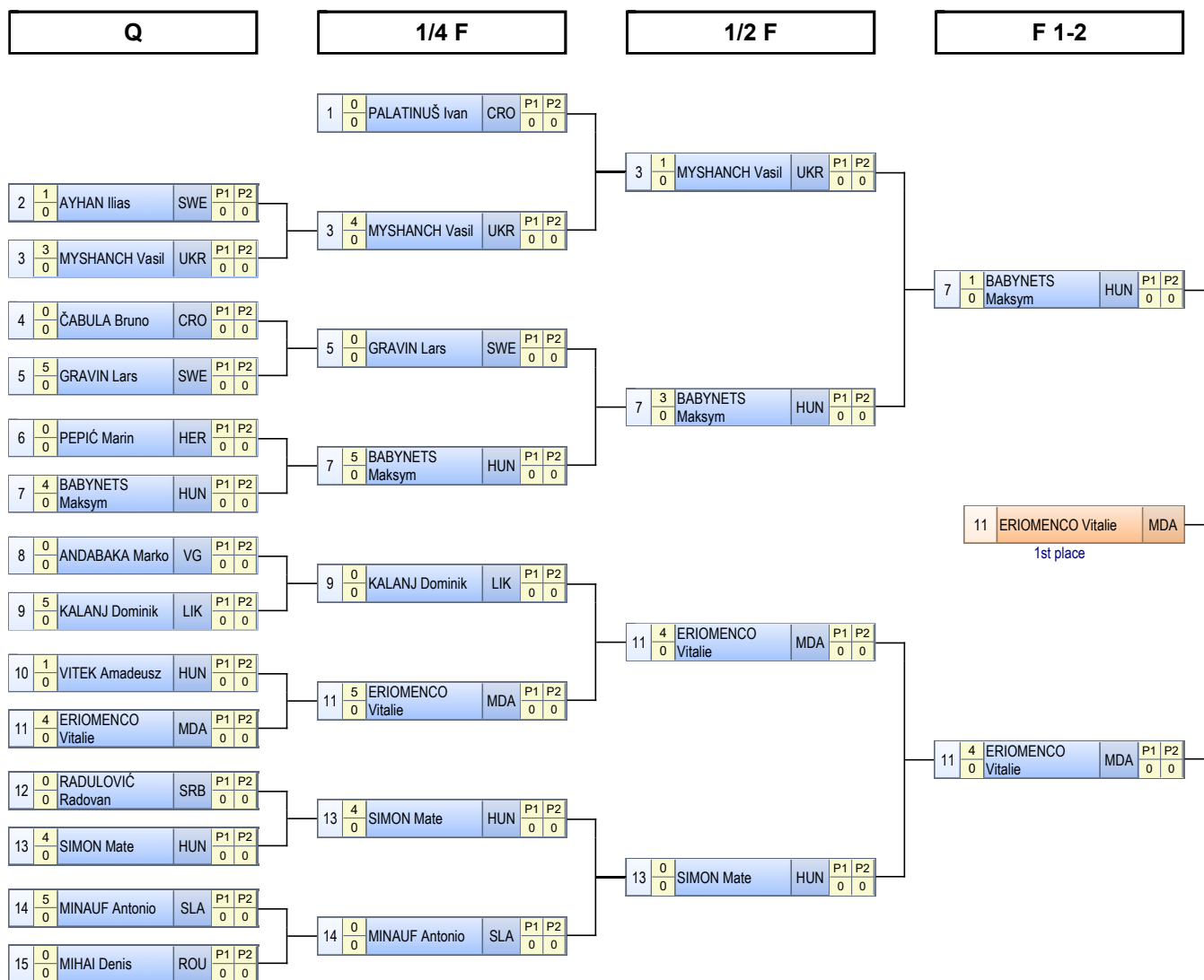

KONAČNI POREDAK

Plasman	Hrvač	Ekipa
1	ERIOMENCO Vitalie	MDA
2	BABYNETS Maksym	HUN
3	MYSHANCH Vasil	UKR
3	VITEK Amadeusz	HUN
5	GRAVIN Lars	SWE
5	SIMON Mate	HUN
7	KALANJ Dominik	LIKA
8	MINAUF Antonio	SLAT
9	AYHAN Ilias	SWE
10	PALATINUŠ Ivan	CRO
10	ČABULA Bruno	CRO
10	PEPIĆ Marin	HER
10	ANDABAKA Marko	VG
10	RADULOVIĆ Radovan	SRB
10	MIHAI Denis	ROU

Repechage A

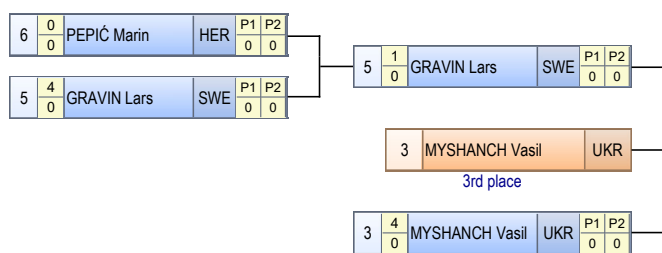

Repechage B

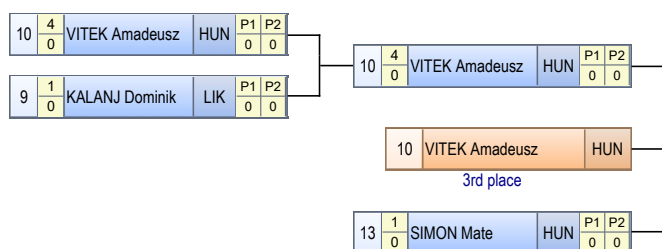

1 - Zlato

ERIOMENCO Vitalie
2 - Srebro

BABYNETS Maksym
3 - Bronca

MYSHANCH Vasil

VITEK Amadeusz

Plasman	Ime	Ekipa	MT	MW	ML	CP	VF	VS	RS	TS	TG
1	ERIOMENCO Vitalie	MDA	4	4	0	17	1	3	0	0	0
2	BABYNETS Maksym	HUN	4	3	1	13	1	1	0	0	0
3	MYSHANCH Vasil	UKR	4	3	1	12	0	2	0	0	0
3	VITEK Amadeusz	HUN	3	2	1	9	0	2	0	0	0
5	GRAVIN Lars	SWE	4	2	2	10	1	1	0	0	0
5	SIMON Mate	HUN	4	2	2	9	0	2	0	0	0
7	KALANJ Dominik	LIKA	3	1	2	6	1	0	0	0	0
8	MINAUF Antonio	SLAT	2	1	1	5	1	0	0	0	0
9	AYHAN Ilias	SWE	1	0	1	1	0	0	0	0	0
10	PALATINUŠ Ivan	CRO	1	0	1	0	0	0	0	0	0
10	ČABULA Bruno	CRO	1	0	1	0	0	0	0	0	0
10	PEPIĆ Marin	HER	2	0	2	0	0	0	0	0	0
10	ANDABAKA Marko	VG	1	0	1	0	0	0	0	0	0
10	RADULOVIĆ Radovan	SRB	1	0	1	0	0	0	0	0	0
10	MIHAI Denis	ROU	1	0	1	0	0	0	0	0	0

MT - matches total, **MW** - matches won, **ML** - matches lost, **CP** - classification points, **VF** - match victories by fall, **VS** - match victories by superiority,
RS - round victories by superiority, **TS** - technical points scored, **TG** - technical points given



DETALJI BORBI

XXVII. Međunarodni Božićni turnir GR

KAD GR 51 kg

185	Q	SWE	AYHAN Ilias	1	PP	0	0		
		UKR	MYSHANCH Vasil	3		0	0		
186	Q	CRO	ČABULA Bruno	0	VT	0	0		
		SWE	GRAVIN Lars	5		0	0		
187	Q	HER	PEPIĆ Marin	0	ST	0	0		
		HUN	BABYNETS Maksym	4		0	0		
188	Q	VG	ANDABAKA Marko	0	VT	0	0		
		LIKA	KALANJ Dominik	5		0	0		
189	Q	HUN	VITEK Amadeusz	1	SP	0	0		
		MDA	ERIOMENCO Vitalie	4		0	0		
190	Q	SRB	RADULOVIĆ Radovan	0	ST	0	0		
		HUN	SIMON Mate	4		0	0		
191	Q	SLAT	MINAUF Antonio	5	VT	0	0		
		ROU	MIHAI Denis	0		0	0		
200	1/4 F	CRO	PALATINUŠ Ivan	0	ST	0	0		
		UKR	MYSHANCH Vasil	4		0	0		
201	1/4 F	SWE	GRAVIN Lars	0	VT	0	0		
		HUN	BABYNETS Maksym	5		0	0		
202	1/4 F	LIKA	KALANJ Dominik	0	VT	0	0		
		MDA	ERIOMENCO Vitalie	5		0	0		
203	1/4 F	HUN	SIMON Mate	4	ST	0	0		
		SLAT	MINAUF Antonio	0		0	0		
216	1/2 F	UKR	MYSHANCH Vasil	1	PP	0	0		
		HUN	BABYNETS Maksym	3		0	0		
217	1/2 F	MDA	ERIOMENCO Vitalie	4	ST	0	0		
		HUN	SIMON Mate	0		0	0		
226	RB1	HUN	VITEK Amadeusz	4	SP	0	0		
		LIKA	KALANJ Dominik	1		0	0		
227	RA1	HER	PEPIĆ Marin	0	ST	0	0		
		SWE	GRAVIN Lars	4		0	0		
230	F 3-5	HUN	VITEK Amadeusz	4	SP	0	0		
		HUN	SIMON Mate	1		0	0		
231	F 3-5	SWE	GRAVIN Lars	1	SP	0	0		
		UKR	MYSHANCH Vasil	4		0	0		
239	F 1-2	HUN	BABYNETS Maksym	1	SP	0	0		
		MDA	ERIOMENCO Vitalie	4		0	0		



TECHNICAL POINTS SUMMARY

XXVII. Međunarodni Božićni turnir GR

KAD GR 51 kg

■ 1 point ■ 2 points ■ 4 points ■ 5 points

1.	ERIOMENCO Vitalie		MDA	0	(4m)
2.	BABYNETS Maksym		HUN	0	(4m)
3.	MYSHANCH Vasil		UKR	0	(4m)
3.	VITEK Amadeusz		HUN	0	(3m)
5.	GRAVIN Lars		SWE	0	(4m)
5.	SIMON Mate		HUN	0	(4m)
7.	KALANJ Dominik	·	LIKA	0	(3m)
8.	MINAUF Antonio	·	SLAT	0	(2m)
9.	AYHAN Ilias		SWE	0	(1m)
10.	PALATINUŠ Ivan		CRO	0	(1m)
10.	ČABULA Bruno		CRO	0	(1m)
10.	PEPIĆ Marin	·	HER	0	(2m)
10.	ANDABAKA Marko	·	VG	0	(1m)
10.	RADULOVIĆ Radovan		SRB	0	(1m)
10.	MIHAI Denis		ROU	0	(1m)

0 TOTAL POINTS 18 TOTAL MATCHES 0,0 POINTS PER MATCH



TABLICA ELIMINACIJE

XXVII. Međunarodni Božićni turnir GR

KAD GR 55 kg

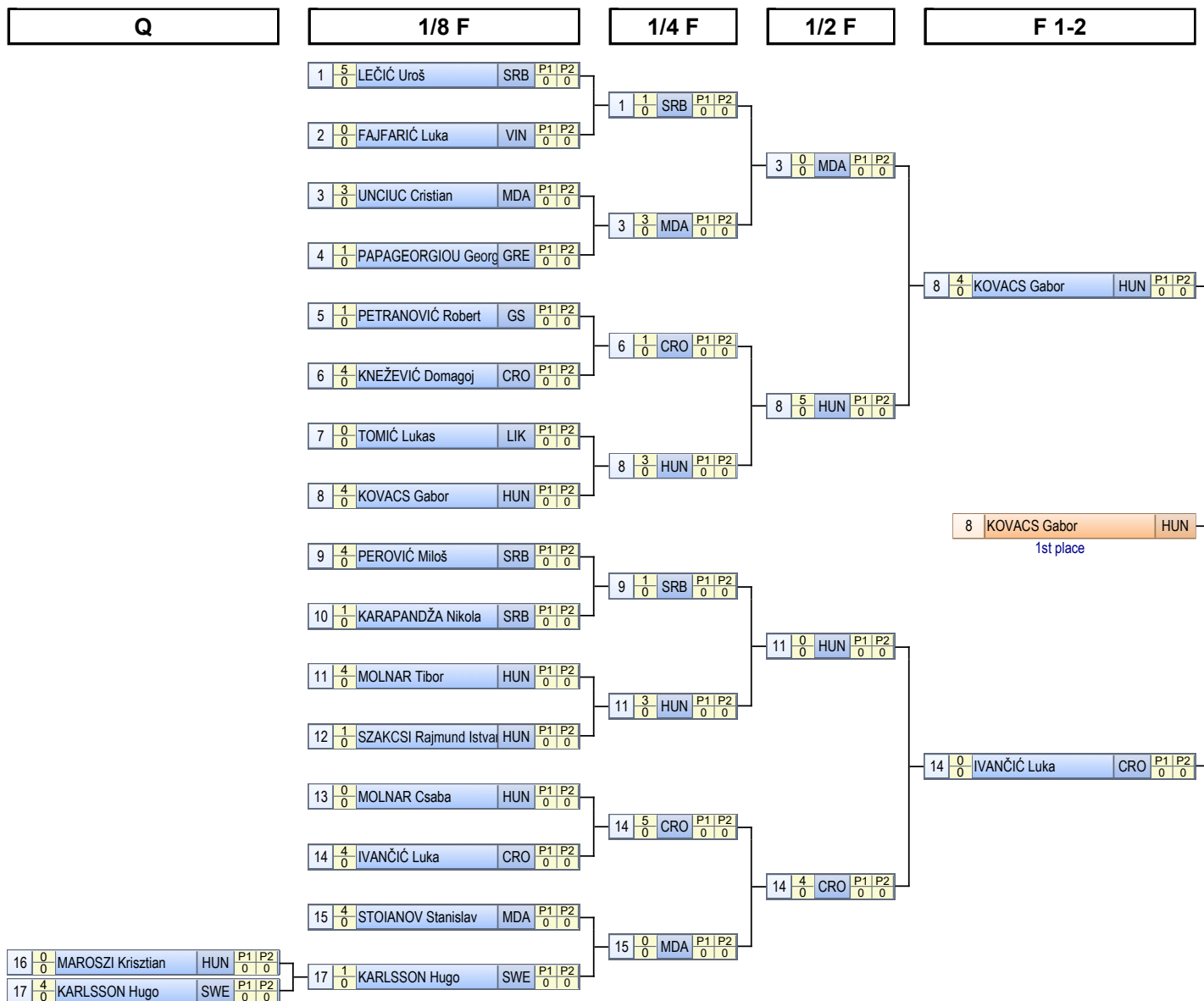

Repechage A

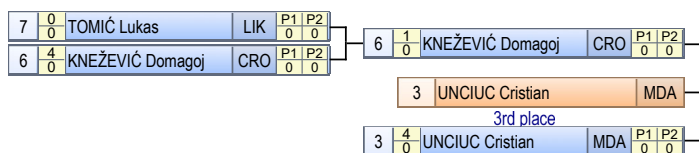

Repechage B

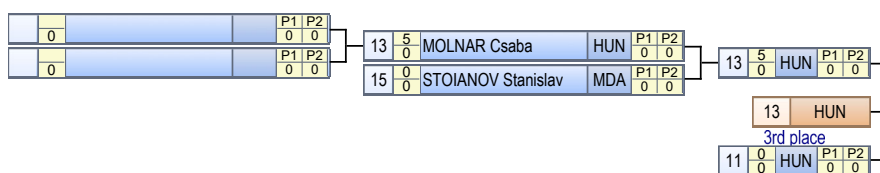

KONAČNI POREDAK

Plasman	Hrvač	Ekipa
1	KOVACS Gabor	HUN
2	IVANČIĆ Luka	CRO
3	UNCIUC Cristian	MDA
3	MOLNAR Csaba	HUN
5	KNEŽEVIĆ Domagoj	CRO
5	MOLNAR Tibor	HUN
7	LEČIĆ Uroš	SRB
8	PEROVIĆ Miloš	SRB
8	KARLSSON Hugo	SWE
10	STOIANOV Stanislav	MDA
11	PAPAGEORGIOU Georgios	GRE
11	PETRANOVIĆ Robert	GS
11	KARAPANDŽA Nikola	SRB
11	SZAKCSI Rajmund Istvan	HUN
15	FAJFARIĆ Luka	VIND
15	TOMIĆ Lukas	LIKA
15	MAROSZI Krisztian	HUN

1 - Zlato

KOVACS Gabor
2 - Srebro

IVANČIĆ Luka
3 - Bronca

UNCIUC Cristian

MOLNAR Csaba

Plasman	Ime	Ekipa	MT	MW	ML	CP	VF	VS	RS	TS	TG
1	KOVACS Gabor	HUN	4	4	0	16	1	2	0	0	0
2	IVANČIĆ Luka	CRO	4	3	1	13	1	2	0	0	0
3	UNCIUC Cristian	MDA	4	3	1	10	0	1	0	0	0
3	MOLNAR Csaba	HUN	3	2	1	10	2	0	0	0	0
5	KNEŽEVIĆ Domagoj	CRO	4	2	2	10	0	2	0	0	0
5	MOLNAR Tibor	HUN	4	2	2	7	0	1	0	0	0
7	LEČIĆ Uroš	SRB	2	1	1	6	1	0	0	0	0
8	PEROVIĆ Miloš	SRB	2	1	1	5	0	1	0	0	0
8	KARLSSON Hugo	SWE	2	1	1	5	0	1	0	0	0
10	STOIANOV Stanislav	MDA	3	1	2	4	0	1	0	0	0
11	PAPAGEORGIOU Georgios	GRE	1	0	1	1	0	0	0	0	0
11	PETRANOVIĆ Robert	GS	1	0	1	1	0	0	0	0	0
11	KARAPANDŽA Nikola	SRB	1	0	1	1	0	0	0	0	0
11	SZAKCSI Rajmund Istvan	HUN	1	0	1	1	0	0	0	0	0
15	FAJFARIĆ Luka	VIND	1	0	1	0	0	0	0	0	0
15	TOMIĆ Lukas	LIKA	2	0	2	0	0	0	0	0	0
15	MAROSZI Krisztian	HUN	1	0	1	0	0	0	0	0	0

MT - matches total, **MW** - matches won, **ML** - matches lost, **CP** - classification points, **VF** - match victories by fall, **VS** - match victories by superiority,
RS - round victories by superiority, **TS** - technical points scored, **TG** - technical points given



DETALJI BORBI

XXVII. Međunarodni Božićni turnir GR

KAD GR 55 kg

192	Q	HUN	MAROSZI Krisztian	0	ST	0	0		
		SWE	KARLSSON Hugo	4		0	0		
204	1/8 F	SRB	LEČIĆ Uroš	5	VT	0	0		
		VIND	FAJFARIĆ Luka	0		0	0		
205	1/8 F	MDA	UNCIUC Cristian	3	PP	0	0		
		GRE	PAPAGEORGIU Georg	1		0	0		
206	1/8 F	GS	PETRANOVIĆ Robert	1	SP	0	0		
		CRO	KNEŽEVIĆ Domagoj	4		0	0		
207	1/8 F	LIKA	TOMIĆ Lukas	0	ST	0	0		
		HUN	KOVACS Gabor	4		0	0		
208	1/8 F	SRB	PEROVIĆ Miloš	4	SP	0	0		
		SRB	KARAPANDŽA Nikola	1		0	0		
209	1/8 F	HUN	MOLNAR Tibor	4	SP	0	0		
		HUN	SZAKCSI Rajmund Istva	1		0	0		
210	1/8 F	HUN	MOLNAR Csaba	0	ST	0	0		
		CRO	IVANČIĆ Luka	4		0	0		
211	1/8 F	MDA	STOIANOV Stanislav	4	SP	0	0		
		SWE	KARLSSON Hugo	1		0	0		
218	1/4 F	SRB	LEČIĆ Uroš	1	PP	0	0		
		MDA	UNCIUC Cristian	3		0	0		
219	1/4 F	CRO	KNEŽEVIĆ Domagoj	1	PP	0	0		
		HUN	KOVACS Gabor	3		0	0		
220	1/4 F	SRB	PEROVIĆ Miloš	1	PP	0	0		
		HUN	MOLNAR Tibor	3		0	0		
221	1/4 F	CRO	IVANČIĆ Luka	5	VT	0	0		
		MDA	STOIANOV Stanislav	0		0	0		
224	1/2 F	MDA	UNCIUC Cristian	0	VT	0	0		
		HUN	KOVACS Gabor	5		0	0		
225	1/2 F	HUN	MOLNAR Tibor	0	ST	0	0		
		CRO	IVANČIĆ Luka	4		0	0		
233	RA1	LIKA	TOMIĆ Lukas	0	ST	0	0		
		CRO	KNEŽEVIĆ Domagoj	4		0	0		
236	RB2	HUN	MOLNAR Csaba	5	VT	0	0		
		MDA	STOIANOV Stanislav	0		0	0		
237	F 3-5	CRO	KNEŽEVIĆ Domagoj	1	SP	0	0		
		MDA	UNCIUC Cristian	4		0	0		
238	F 3-5	HUN	MOLNAR Csaba	5	VT	0	0		
		HUN	MOLNAR Tibor	0		0	0		



DETALJI BORBI

XXVII. Međunarodni Božićni turnir GR

KAD GR 55 kg

240	F 1-2	HUN	KOVACS Gabor	4	ST		0		0	
		CRO	IVANČIĆ Luka	0			0		0	



TECHNICAL POINTS SUMMARY

XXVII. Međunarodni Božićni turnir GR

KAD GR 55 kg

■ 1 point ■ 2 points ■ 4 points ■ 5 points

1.	KOVACS Gabor	 HUN	0 (4m)
2.	IVANČIĆ Luka	 CRO	0 (4m)
3.	UNCIUC Cristian	 MDA	0 (4m)
3.	MOLNAR Csaba	 HUN	0 (3m)
5.	KNEŽEVIĆ Domagoj	 CRO	0 (4m)
5.	MOLNAR Tibor	 HUN	0 (4m)
7.	LEČIĆ Uroš	 SRB	0 (2m)
8.	PEROVIĆ Miloš	 SRB	0 (2m)
8.	KARLSSON Hugo	 SWE	0 (2m)
10.	STOIANOV Stanislav	 MDA	0 (3m)
11.	PAPAGEORGIU Georgios	 GRE	0 (1m)
11.	PETRANOVIĆ Robert	· GS	0 (1m)
11.	KARAPANDŽA Nikola	 SRB	0 (1m)
11.	SZAKCSI Rajmund Istvan	 HUN	0 (1m)
15.	FAJFARIĆ Luka	· VIND	0 (1m)
15.	TOMIĆ Lukas	· LIKA	0 (2m)
15.	MAROSZI Krisztian	 HUN	0 (1m)

0 TOTAL POINTS 20 TOTAL MATCHES 0,0 POINTS PER MATCH



TABLICA ELIMINACIJE

XXVII. Međunarodni Božićni turnir GR

KAD GR 60 kg

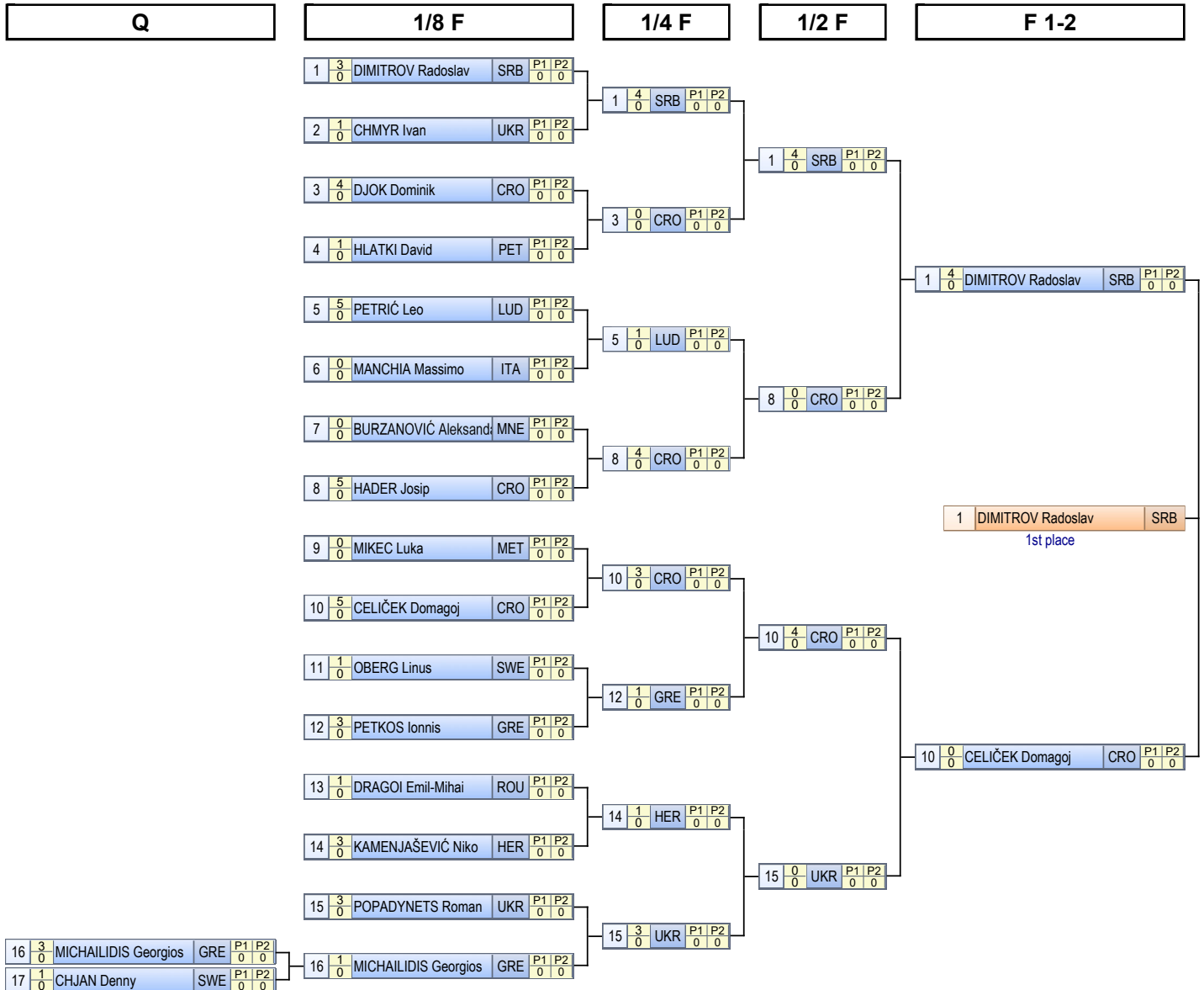

Repechage A

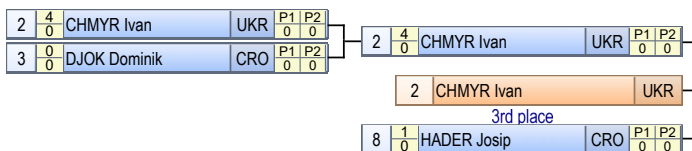

Repechage B

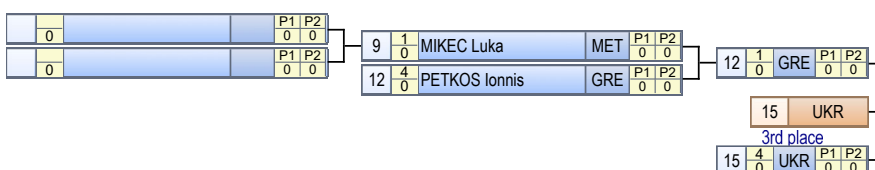

KONAČNI POREDAK

Plasman	Hrvač	Ekipa
1	DIMITROV Radoslav	SRB
2	CELIČEK Domagoj	CRO
3	CHMYR Ivan	UKR
3	POPADYNETS Roman	UKR
5	HADER Josip	CRO
5	PETKOS Ionnis	GRE
7	PETRIĆ Leo	LUDB
8	DJOK Dominik	CRO
9	KAMENJAŠEVIĆ Niko	HER
9	MICHAILIDIS Georgios	GRE
11	HLATKI David	PETR
11	MIKEC Luka	MET
11	OBERG Linus	SWE
11	DRAGOI Emil-Mihai	ROU
11	CHJAN Denny	SWE
16	MANCHIA Massimo	ITA
16	BURZANOVIĆ Aleksandar	MNE

1 - Zlato

DIMITROV Radoslav

2 - Srebro

CELIČEK Domagoj

3 - Bronca

CHMYR Ivan



POPADYNETS Roman

Plasman	Ime	Ekipa	MT	MW	ML	CP	VF	VS	RS	TS	TG
1	DIMITROV Radoslav	SRB	4	4	0	15	0	3	0	0	0
2	CELIČEK Domagoj	CRO	4	3	1	12	1	1	0	0	0
3	CHMYR Ivan	UKR	3	2	1	9	0	2	0	0	0
3	POPADYNETS Roman	UKR	4	3	1	10	0	1	0	0	0
5	HADER Josip	CRO	4	2	2	10	1	1	0	0	0
5	PETKOS Ionnis	GRE	4	2	2	9	0	1	0	0	0
7	PETRIĆ Leo	LUDB	2	1	1	6	1	0	0	0	0
8	DJOK Dominik	CRO	3	1	2	4	0	1	0	0	0
9	KAMENJAŠEVIĆ Niko	HER	2	1	1	4	0	0	0	0	0
9	MICHAILIDIS Georgios	GRE	2	1	1	4	0	0	0	0	0
11	HLATKI David	PETR	1	0	1	1	0	0	0	0	0
11	MIKEC Luka	MET	2	0	2	1	0	0	0	0	0
11	OBERG Linus	SWE	1	0	1	1	0	0	0	0	0
11	DRAGOI Emil-Mihai	ROU	1	0	1	1	0	0	0	0	0
11	CHJAN Denny	SWE	1	0	1	1	0	0	0	0	0
16	MANCHIA Massimo	ITA	1	0	1	0	0	0	0	0	0
16	BURZANOVIĆ Aleksandar	MNE	1	0	1	0	0	0	0	0	0

MT - matches total, **MW** - matches won, **ML** - matches lost, **CP** - classification points, **VF** - match victories by fall, **VS** - match victories by superiority,
RS - round victories by superiority, **TS** - technical points scored, **TG** - technical points given



DETALJI BORBI

XXVII. Međunarodni Božićni turnir GR

KAD GR 60 kg

128	Q	GRE	MICHAILIDIS Georgios	3	PP	0	0		
		SWE	CHJAN Denny	1		0	0		
141	1/8 F	SRB	DIMITROV Radoslav	3	PP	0	0		
		UKR	CHMYR Ivan	1		0	0		
142	1/8 F	CRO	DJOK Dominik	4	SP	0	0		
		PETR	HLATKI David	1		0	0		
143	1/8 F	LUDB	PETRIĆ Leo	5	VT	0	0		
		ITA	MANCHIA Massimo	0		0	0		
144	1/8 F	MNE	BURZANOVIĆ Aleksand	0	VT	0	0		
		CRO	HADER Josip	5		0	0		
145	1/8 F	MET	MIKEC Luka	0	VT	0	0		
		CRO	CELIČEK Domagoj	5		0	0		
146	1/8 F	SWE	OBBERG Linus	1	PP	0	0		
		GRE	PETKOS Ionnis	3		0	0		
147	1/8 F	ROU	DRAGOI Emil-Mihai	1	PP	0	0		
		HER	KAMENJAŠEVIĆ Niko	3		0	0		
148	1/8 F	UKR	POPADYNETS Roman	3	PP	0	0		
		GRE	MICHAILIDIS Georgios	1		0	0		
157	1/4 F	SRB	DIMITROV Radoslav	4	ST	0	0		
		CRO	DJOK Dominik	0		0	0		
158	1/4 F	LUDB	PETRIĆ Leo	1	SP	0	0		
		CRO	HADER Josip	4		0	0		
159	1/4 F	CRO	CELIČEK Domagoj	3	PP	0	0		
		GRE	PETKOS Ionnis	1		0	0		
160	1/4 F	HER	KAMENJAŠEVIĆ Niko	1	PP	0	0		
		UKR	POPADYNETS Roman	3		0	0		
165	1/2 F	SRB	DIMITROV Radoslav	4	ST	0	0		
		CRO	HADER Josip	0		0	0		
166	1/2 F	CRO	CELIČEK Domagoj	4	ST	0	0		
		UKR	POPADYNETS Roman	0		0	0		
176	RA1	UKR	CHMYR Ivan	4	ST	0	0		
		CRO	DJOK Dominik	0		0	0		
179	RB2	MET	MIKEC Luka	1	SP	0	0		
		GRE	PETKOS Ionnis	4		0	0		
180	F 3-5	UKR	CHMYR Ivan	4	SP	0	0		
		CRO	HADER Josip	1		0	0		
181	F 3-5	GRE	PETKOS Ionnis	1	SP	0	0		
		UKR	POPADYNETS Roman	4		0	0		



DETALJI BORBI

XXVII. Međunarodni Božićni turnir GR

KAD GR 60 kg

182	F 1-2	SRB	DIMITROV Radoslav	4	ST		0		0	
		CRO	CELIČEK Domagoj	0			0		0	



TECHNICAL POINTS SUMMARY

XXVII. Međunarodni Božićni turnir GR

KAD GR 60 kg

■ 1 point ■ 2 points ■ 4 points ■ 5 points

1.	DIMITROV Radoslav		SRB	0 (4m)
2.	CELIČEK Domagoj		CRO	0 (4m)
3.	CHMYR Ivan		UKR	0 (3m)
3.	POPADYNETS Roman		UKR	0 (4m)
5.	HADER Josip		CRO	0 (4m)
5.	PETKOS Ionnis		GRE	0 (4m)
7.	PETRIĆ Leo		· LUDB	0 (2m)
8.	DJOK Dominik		CRO	0 (3m)
9.	KAMENJAŠEVIĆ Niko		· HER	0 (2m)
9.	MICHAILIDIS Georgios		GRE	0 (2m)
11.	HLATKI David		· PETR	0 (1m)
11.	MIKEC Luka		· MET	0 (2m)
11.	OBERG Linus		SWE	0 (1m)
11.	DRAGOI Emil-Mihai		ROU	0 (1m)
11.	CHJAN Denny		SWE	0 (1m)
16.	MANCHIA Massimo		ITA	0 (1m)
16.	BURZANOVIĆ Aleksandar		MNE	0 (1m)

0 TOTAL POINTS 20 TOTAL MATCHES 0,0 POINTS PER MATCH



TABLICA ELIMINACIJE

XXVII. Međunarodni Božićni turnir GR

KAD GR 65 kg

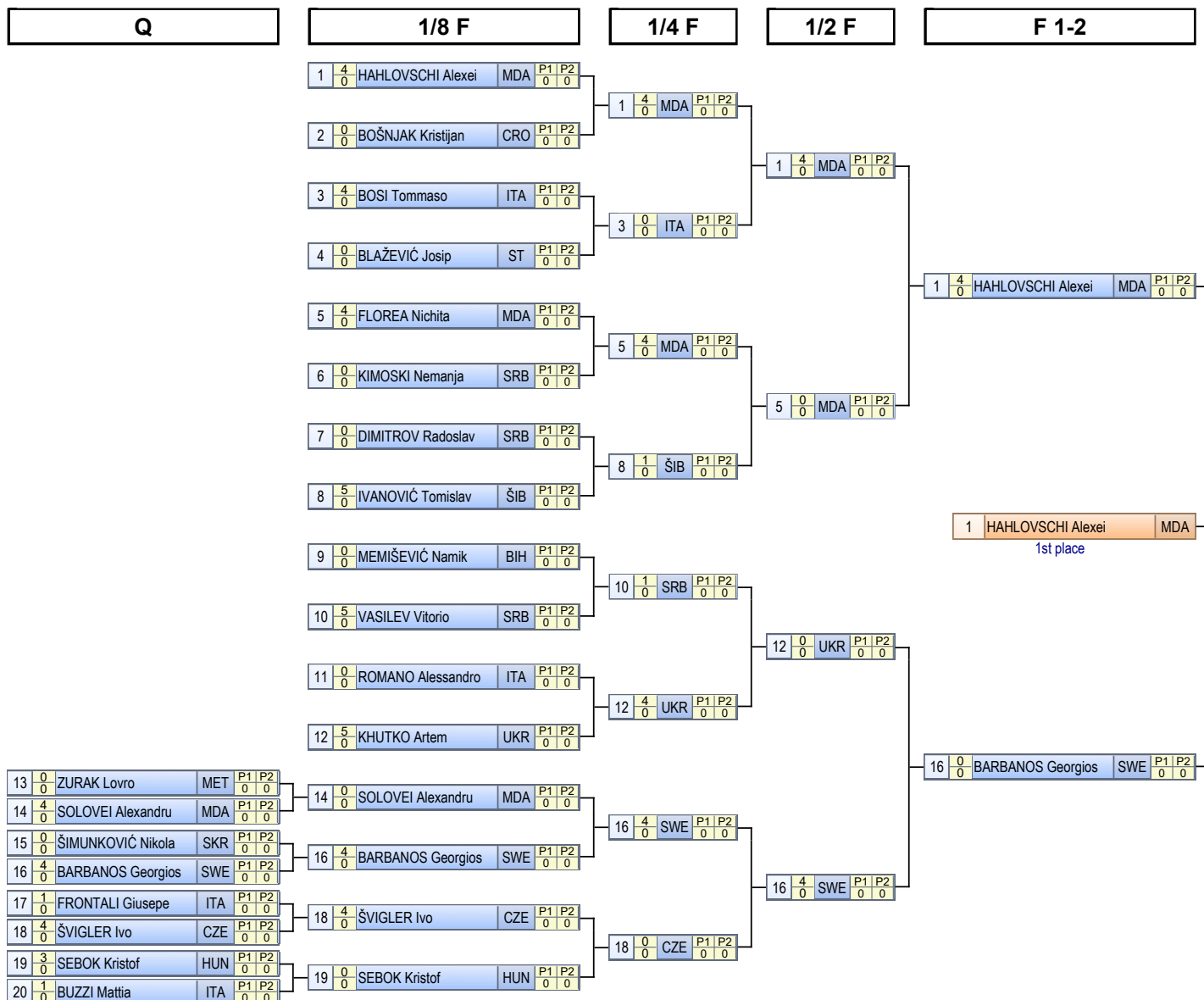

Repechage A

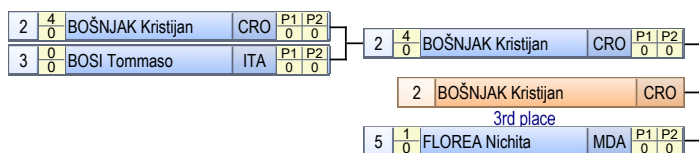

Repechage B

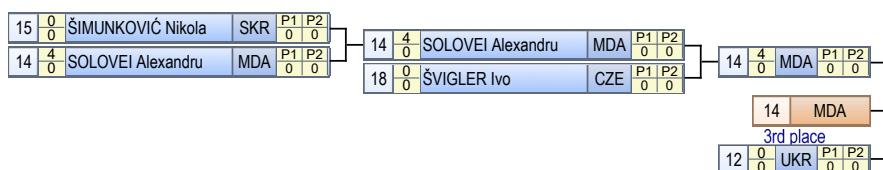

KONAČNI POREDAK

Plasman	Hrvač	Ekipa
1	HAHLOVSCHI Alexei	MDA
2	BARBANOS Georgios	SWE
3	BOŠNJAK Kristijan	CRO
3	SOLOVEI Alexandru	MDA
5	FLOREA Nichita	MDA
5	KHUTKO Artem	UKR
7	ŠVIGLER Ivo	CZE
8	IVANOVIĆ Tomislav	ŠIB
8	VASILEV Vitorio	SRB
10	BOSI Tommaso	ITA
11	SEBOK Kristof	HUN
12	FRONTALI Giuseppe	ITA
12	BUZZI Mattia	ITA
14	BLAŽEVIĆ Josip	ST
14	KIMOSKI Nemanja	SRB
14	DIMITROV Radoslav	SRB
14	MEMIŠEVIĆ Namik	BIH
14	ROMANO Alessandro	ITA
14	ZURAK Lovro	MET
14	ŠIMUNKOVIĆ Nikola	SKR

1 - Zlato

HAHLOVSCHI Alexei
2 - Srebro

BARBANOS Georgios
3 - Bronca

BOŠNJAK Kristijan

SOLOVEI Alexandru

Plasman	Ime	Ekipa	MT	MW	ML	CP	VF	VS	RS	TS	TG
1	HAHLOVSCHI Alexei	MDA	4	4	0	16	0	4	0	0	0
2	BARBANOS Georgios	SWE	5	4	1	16	0	4	0	0	0
3	BOŠNJAK Kristijan	CRO	3	2	1	8	0	2	0	0	0
3	SOLOVEI Alexandru	MDA	5	4	1	16	0	4	0	0	0
5	FLOREA Nichita	MDA	4	2	2	9	0	2	0	0	0
5	KHUTKO Artem	UKR	4	2	2	9	1	1	0	0	0
7	ŠVIGLER Ivo	CZE	4	2	2	8	0	2	0	0	0
8	IVANOVIĆ Tomislav	ŠIB	2	1	1	6	1	0	0	0	0
8	VASILEV Vitorio	SRB	2	1	1	6	1	0	0	0	0
10	BOSI Tommaso	ITA	3	1	2	4	0	1	0	0	0
11	SEBOK Kristof	HUN	2	1	1	3	0	0	0	0	0
12	FRONTALI Giusepe	ITA	1	0	1	1	0	0	0	0	0
12	BUZZI Mattia	ITA	1	0	1	1	0	0	0	0	0
14	BLAŽEVIĆ Josip	ST	1	0	1	0	0	0	0	0	0
14	KIMOSKI Nemanja	SRB	1	0	1	0	0	0	0	0	0
14	DIMITROV Radoslav	SRB	1	0	1	0	0	0	0	0	0
14	MEMIŠEVIĆ Namik	BIH	1	0	1	0	0	0	0	0	0
14	ROMANO Alessandro	ITA	1	0	1	0	0	0	0	0	0
14	ZURAK Lovro	MET	1	0	1	0	0	0	0	0	0
14	ŠIMUNKOVIĆ Nikola	SKR	2	0	2	0	0	0	0	0	0

MT - matches total, **MW** - matches won, **ML** - matches lost, **CP** - classification points, **VF** - match victories by fall, **VS** - match victories by superiority,
RS - round victories by superiority, **TS** - technical points scored, **TG** - technical points given



DETALJI BORBI

XXVII. Međunarodni Božićni turnir GR

KAD GR 65 kg

242	Q	MET	ZURAK Lovro	0	ST	0	0		
		MDA	SOLOVEI Alexandru	4		0	0		
243	Q	SKR	ŠIMUNKOVIĆ Nikola	0	ST	0	0		
		SWE	BARBANOS Georgios	4		0	0		
244	Q	ITA	FRONTALI Giusepe	1	SP	0	0		
		CZE	ŠVIGLER Ivo	4		0	0		
245	Q	HUN	SEBOK Kristof	3	PP	0	0		
		ITA	BUZZI Mattia	1		0	0		
255	1/8 F	MDA	HAHLOVSCHI Alexei	4	ST	0	0		
		CRO	BOŠNJAK Kristijan	0		0	0		
256	1/8 F	ITA	BOSI Tommaso	4	ST	0	0		
		ST	BLAŽEVIĆ Josip	0		0	0		
257	1/8 F	MDA	FLOREA Nichita	4	ST	0	0		
		SRB	KIMOSKI Nemanja	0		0	0		
258	1/8 F	SRB	DIMITROV Radoslav	0	VT	0	0		
		ŠIB	IVANOVIĆ Tomislav	5		0	0		
259	1/8 F	BIH	MEMIŠEVIĆ Namik	0	VT	0	0		
		SRB	VASILEV Vitorio	5		0	0		
260	1/8 F	ITA	ROMANO Alessandro	0	VT	0	0		
		UKR	KHUTKO Artem	5		0	0		
261	1/8 F	MDA	SOLOVEI Alexandru	0	ST	0	0		
		SWE	BARBANOS Georgios	4		0	0		
262	1/8 F	CZE	ŠVIGLER Ivo	4	ST	0	0		
		HUN	SEBOK Kristof	0		0	0		
273	1/4 F	MDA	HAHLOVSCHI Alexei	4	ST	0	0		
		ITA	BOSI Tommaso	0		0	0		
274	1/4 F	MDA	FLOREA Nichita	4	SP	0	0		
		ŠIB	IVANOVIĆ Tomislav	1		0	0		
275	1/4 F	SRB	VASILEV Vitorio	1	SP	0	0		
		UKR	KHUTKO Artem	4		0	0		
276	1/4 F	SWE	BARBANOS Georgios	4	ST	0	0		
		CZE	ŠVIGLER Ivo	0		0	0		
283	1/2 F	MDA	HAHLOVSCHI Alexei	4	ST	0	0		
		MDA	FLOREA Nichita	0		0	0		
284	1/2 F	UKR	KHUTKO Artem	0	ST	0	0		
		SWE	BARBANOS Georgios	4		0	0		
290	RB1	SKR	ŠIMUNKOVIĆ Nikola	0	ST	0	0		
		MDA	SOLOVEI Alexandru	4		0	0		



DETALJI BORBI

XXVII. Međunarodni Božićni turnir GR

KAD GR 65 kg

291	RA1	CRO	BOŠNJAK Kristijan	4	ST	0	0		
		ITA	BOSI Tommaso	0		0	0		
294	RB2	MDA	SOLOVEI Alexandru	4	ST	0	0		
		CZE	ŠVIGLER Ivo	0		0	0		
296	F 3-5	CRO	BOŠNJAK Kristijan	4	SP	0	0		
		MDA	FLOREA Nichita	1		0	0		
297	F 3-5	MDA	SOLOVEI Alexandru	4	ST	0	0		
		UKR	KHUTKO Artem	0		0	0		
300	F 1-2	MDA	HAHLOVSCHI Alexei	4	ST	0	0		
		SWE	BARBANOS Georgios	0		0	0		



TECHNICAL POINTS SUMMARY

XXVII. Međunarodni Božićni turnir GR

KAD GR 65 kg

■ 1 point ■ 2 points ■ 4 points ■ 5 points

1.	HAHLOVSCHI Alexei		MDA	0	(4m)
2.	BARBANOS Georgios		SWE	0	(5m)
3.	BOŠNJAK Kristijan		CRO	0	(3m)
3.	SOLOVEI Alexandru		MDA	0	(5m)
5.	FLOREA Nichita		MDA	0	(4m)
5.	KHUTKO Artem		UKR	0	(4m)
7.	ŠVIGLER Ivo		CZE	0	(4m)
8.	IVANOVIĆ Tomislav		ŠIB	0	(2m)
8.	VASILEV Vitorio		SRB	0	(2m)
10.	BOSI Tommaso		ITA	0	(3m)
11.	SEBOK Kristof		HUN	0	(2m)
12.	FRONTALI Giuseppe		ITA	0	(1m)
12.	BUZZI Mattia		ITA	0	(1m)
14.	BLAŽEVIĆ Josip		ST	0	(1m)
14.	KIMOSKI Nemanja		SRB	0	(1m)
14.	DIMITROV Radoslav		SRB	0	(1m)
14.	MEMIŠEVIĆ Namik		BIH	0	(1m)
14.	ROMANO Alessandro		ITA	0	(1m)
14.	ZURAK Lovro		MET	0	(1m)
14.	ŠIMUNKOVIĆ Nikola		SKR	0	(2m)

0 TOTAL POINTS 24 TOTAL MATCHES 0,0 POINTS PER MATCH



TABLICA ELIMINACIJE

XXVII. Međunarodni Božićni turnir GR

KAD GR 71 kg

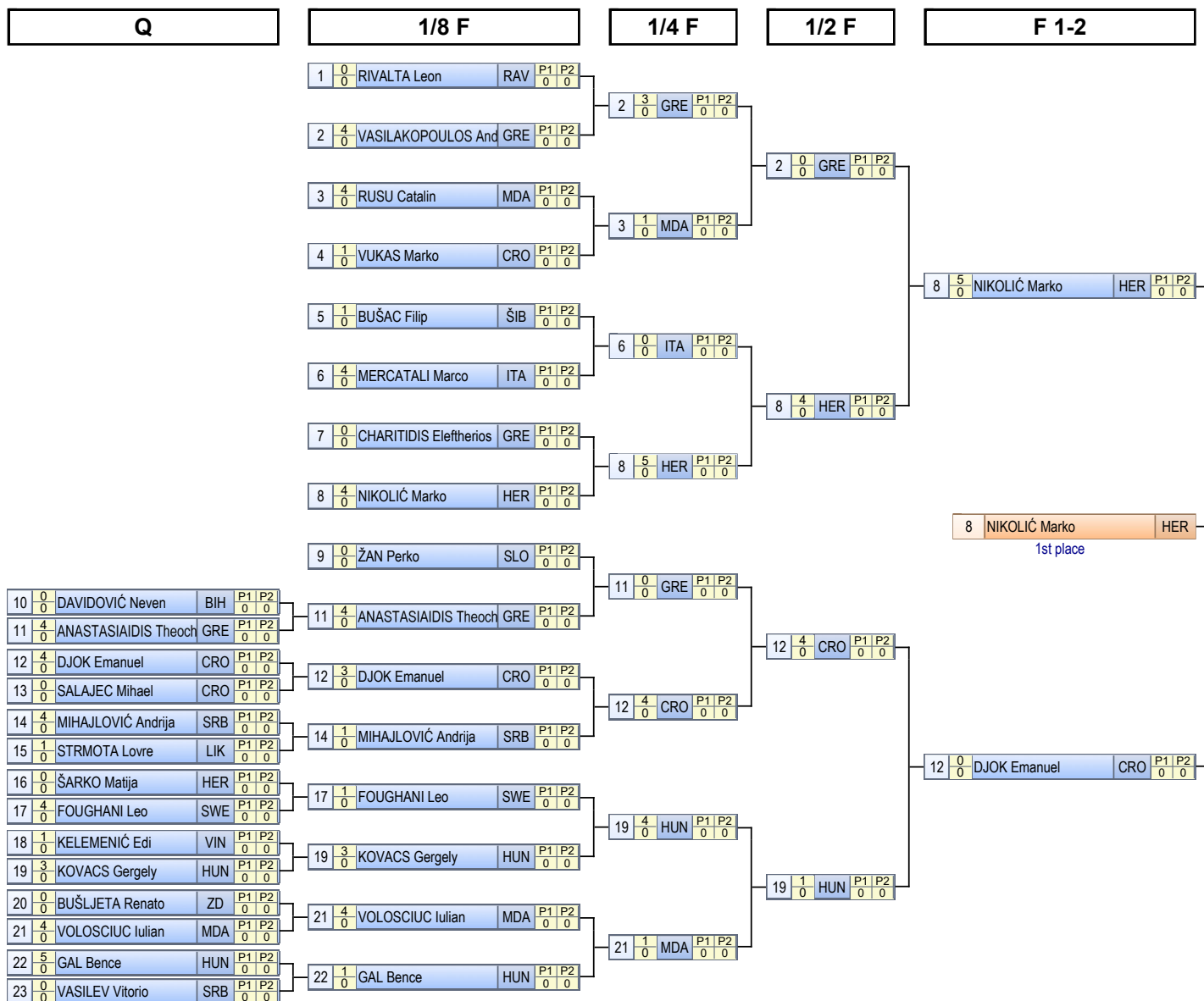

Repechage A

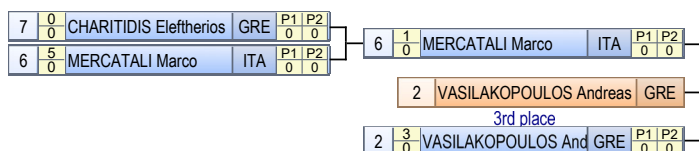

Repechage B

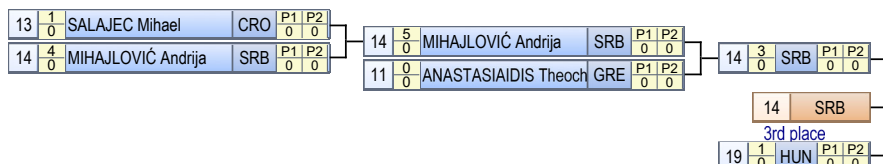

KONAČNI POREDAK

Plasman	Hrvač	Ekipa
1	NIKOLIĆ Marko	HER
2	DJOK Emanuel	CRO
3	VASILAKOPOULOS Andreas	GRE
3	MIHAJLOVIĆ Andrija	SRB
5	MERCATALI Marco	ITA
5	KOVACS Gergely	HUN
7	VOLOSCIUC Iulian	MDA
8	ANASTASIAIDIS Theocharis	GRE
9	GAL Bence	HUN
10	RUSU Catalin	MDA
10	FOUGHANI Leo	SWE
12	VUKAS Marko	CRO
12	BUŠAC Filip	ŠIB
12	SALAJEC Mihael	CRO
12	STRMOTA Lovre	LIKA
12	KELEMENIĆ Edi	VIND
17	RIVALTA Leon	RAV
17	CHARITIDIS Eleftherios	GRE
17	ŽAN Perko	SLO
17	DAVIDOVIĆ Neven	BIH
17	ŠARKO Matija	HER
17	BUŠLJETA Renato	ZD
17	VASILEV Vitorio	SRB

1 - Zlato

NIKOLIĆ Marko
2 - Srebro

DJOK Emanuel
3 - Bronca

VASILAKOPOULOS Andre

MIHAJLOVIĆ Andrija

Plasman	Ime	Ekipa	MT	MW	ML	CP	VF	VS	RS	TS	TG
1	NIKOLIĆ Marko	HER	4	4	0	18	2	2	0	0	0
2	DJOK Emanuel	CRO	5	4	1	15	0	3	0	0	0
3	VASILAKOPOULOS Andreas	GRE	4	3	1	10	0	1	0	0	0
3	MIHAJLOVIĆ Andrija	SRB	5	4	1	17	1	2	0	0	0
5	MERCATALI Marco	ITA	4	2	2	10	1	1	0	0	0
5	KOVACS Gergely	HUN	5	3	2	12	0	1	0	0	0
7	VOLOSCIUC Iulian	MDA	3	2	1	9	0	2	0	0	0
8	ANASTASIAIDIS Theocharis	GRE	4	2	2	8	0	2	0	0	0
9	GAL Bence	HUN	2	1	1	6	1	0	0	0	0
10	RUSU Catalin	MDA	2	1	1	5	0	1	0	0	0
10	FOUGHANI Leo	SWE	2	1	1	5	0	1	0	0	0
12	VUKAS Marko	CRO	1	0	1	1	0	0	0	0	0
12	BUŠAC Filip	ŠIB	1	0	1	1	0	0	0	0	0
12	SALAJEC Mihael	CRO	2	0	2	1	0	0	0	0	0
12	STRMOTA Lovre	LIKA	1	0	1	1	0	0	0	0	0
12	KELEMENIĆ Edi	VIND	1	0	1	1	0	0	0	0	0
17	RIVALTA Leon	RAV	1	0	1	0	0	0	0	0	0
17	CHARITIDIS Eleftherios	GRE	2	0	2	0	0	0	0	0	0
17	ŽAN Perko	SLO	1	0	1	0	0	0	0	0	0
17	DAVIDOVIĆ Neven	BIH	1	0	1	0	0	0	0	0	0
17	ŠARKO Matija	HER	1	0	1	0	0	0	0	0	0
17	BUŠLJETA Renato	ZD	1	0	1	0	0	0	0	0	0
17	VASILEV Vitorio	SRB	1	0	1	0	0	0	0	0	0

MT - matches total, MW - matches won, ML - matches lost, CP - classification points, VF - match victories by fall, VS - match victories by superiority, RS - round victories by superiority, TS - technical points scored, TG - technical points given



DETALJI BORBI

XXVII. Međunarodni Božićni turnir GR

KAD GR 71 kg

246	Q	BIH	DAVIDOVIĆ Neven	0	ST	0	0		
		GRE	ANASTASIAIDIS Theoc	4		0	0		
247	Q	CRO	DJOK Emanuel	4	ST	0	0		
		CRO	SALAJEC Mihael	0		0	0		
248	Q	SRB	MIHAJLOVIĆ Andrija	4	SP	0	0		
		LIKA	STRMOTA Lovre	1		0	0		
249	Q	HER	ŠARKO Matija	0	ST	0	0		
		SWE	FOUGHANI Leo	4		0	0		
250	Q	VIND	KELEMENIĆ Edi	1	PP	0	0		
		HUN	KOVACS Gergely	3		0	0		
251	Q	ZD	BUŠLJETA Renato	0	ST	0	0		
		MDA	VOLOSCIUC Iulian	4		0	0		
252	Q	HUN	GAL Bence	5	VT	0	0		
		SRB	VASILEV Vitorio	0		0	0		
263	1/8 F	RAV	RIVALTA Leon	0	ST	0	0		
		GRE	VASILAKOPOULOS And	4		0	0		
264	1/8 F	MDA	RUSU Catalin	4	SP	0	0		
		CRO	VUKAS Marko	1		0	0		
265	1/8 F	ŠIB	BUŠAC Filip	1	SP	0	0		
		ITA	MERCATALI Marco	4		0	0		
266	1/8 F	GRE	CHARITIDIS Eleftherios	0	ST	0	0		
		HER	NIKOLIĆ Marko	4		0	0		
267	1/8 F	SLO	ŽAN Perko	0	ST	0	0		
		GRE	ANASTASIAIDIS Theoc	4		0	0		
268	1/8 F	CRO	DJOK Emanuel	3	PP	0	0		
		SRB	MIHAJLOVIĆ Andrija	1		0	0		
269	1/8 F	SWE	FOUGHANI Leo	1	PP	0	0		
		HUN	KOVACS Gergely	3		0	0		
270	1/8 F	MDA	VOLOSCIUC Iulian	4	SP	0	0		
		HUN	GAL Bence	1		0	0		
277	1/4 F	GRE	VASILAKOPOULOS And	3	PP	0	0		
		MDA	RUSU Catalin	1		0	0		
278	1/4 F	ITA	MERCATALI Marco	0	VT	0	0		
		HER	NIKOLIĆ Marko	5		0	0		
279	1/4 F	GRE	ANASTASIAIDIS Theoc	0	ST	0	0		
		CRO	DJOK Emanuel	4		0	0		
280	1/4 F	HUN	KOVACS Gergely	4	SP	0	0		
		MDA	VOLOSCIUC Iulian	1		0	0		



DETALJI BORBI

XXVII. Međunarodni Božićni turnir GR

KAD GR 71 kg

285	1/2 F	GRE	VASILAKOPOULOS And	0	ST	0	0		
		HER	NIKOLIĆ Marko	4		0	0		
286	1/2 F	CRO	DJOK Emanuel	4	SP	0	0		
		HUN	KOVACS Gergely	1		0	0		
292	RB1	CRO	SALAJEC Mihael	1	SP	0	0		
		SRB	MIHAJLOVIĆ Andrija	4		0	0		
293	RA1	GRE	CHARITIDIS Eleftherios	0	VT	0	0		
		ITA	MERCATALI Marco	5		0	0		
295	RB2	SRB	MIHAJLOVIĆ Andrija	5	VT	0	0		
		GRE	ANASTASIAIDIS Theoch	0		0	0		
298	F 3-5	ITA	MERCATALI Marco	1	PP	0	0		
		GRE	VASILAKOPOULOS And	3		0	0		
299	F 3-5	SRB	MIHAJLOVIĆ Andrija	3	PP	0	0		
		HUN	KOVACS Gergely	1		0	0		
301	F 1-2	HER	NIKOLIĆ Marko	5	VT	0	0		
		CRO	DJOK Emanuel	0		0	0		



TECHNICAL POINTS SUMMARY

XXVII. Međunarodni Božićni turnir GR

KAD GR 71 kg

■ 1 point ■ 2 points ■ 4 points ■ 5 points

1.	NIKOLIĆ Marko	·	HER	0	(4m)
2.	DJOK Emanuel		CRO	0	(5m)
3.	VASILAKOPOULOS Andreas		GRE	0	(4m)
3.	MIHAJLOVIĆ Andrija		SRB	0	(5m)
5.	MERCATALI Marco		ITA	0	(4m)
5.	KOVACS Gergely		HUN	0	(5m)
7.	VOLOSCIUC Iulian		MDA	0	(3m)
8.	ANASTASIAIDIS Theocharis		GRE	0	(4m)
9.	GAL Bence		HUN	0	(2m)
10.	RUSU Catalin		MDA	0	(2m)
10.	FOUGHANI Leo		SWE	0	(2m)
12.	VUKAS Marko		CRO	0	(1m)
12.	BUŠAC Filip	·	ŠIB	0	(1m)
12.	SALAJEC Mihael		CRO	0	(2m)
12.	STRMOTA Lovre	·	LIKA	0	(1m)
12.	KELEMENIĆ Edi	·	VIND	0	(1m)
17.	RIVALTA Leon	·	RAV	0	(1m)
17.	CHARITIDIS Eleftherios		GRE	0	(2m)
17.	ŽAN Perko		SLO	0	(1m)
17.	DAVIDOVIĆ Neven		BIH	0	(1m)
17.	ŠARKO Matija	·	HER	0	(1m)
17.	BUŠLJETA Renato	·	ZD	0	(1m)
17.	VASILEV Vitorio		SRB	0	(1m)

0 TOTAL POINTS 27 TOTAL MATCHES 0,0 POINTS PER MATCH



TABLICA ELIMINACIJE

XXVII. Međunarodni Božićni turnir GR

KAD GR 80 kg

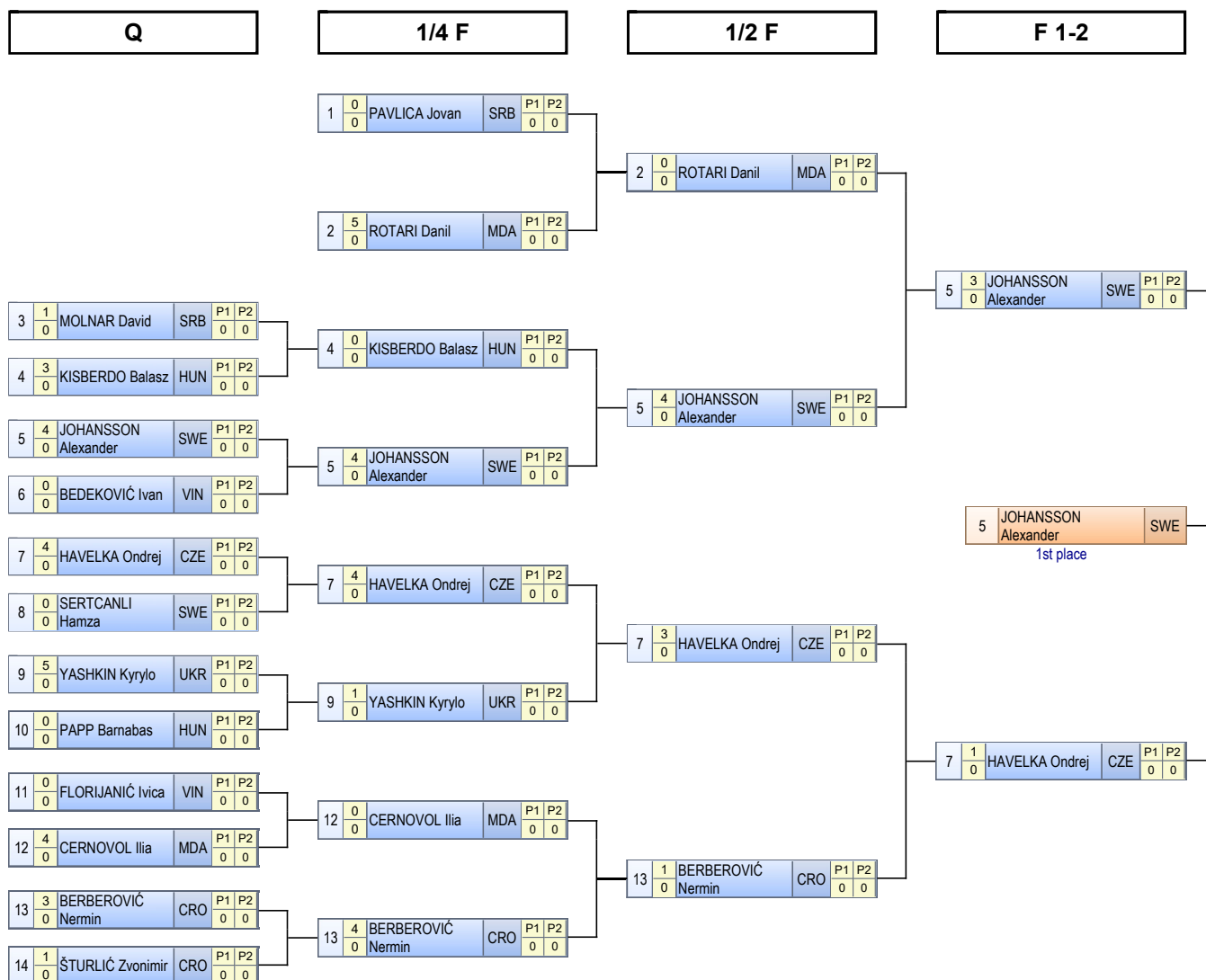

KONAČNI POREDAK

Plasman	Hrvač	Ekipa
1	JOHANSSON Alexander	SWE
2	HAVELKA Ondrej	CZE
3	ROTARI Danil	MDA
3	SERTCANLI Hamza	SWE
5	KISBERDO Balasz	HUN
5	BERBEROVIĆ Nermin	CRO
7	YASHKIN Kyrylo	UKR
8	CERNOVOL Ilija	MDA
9	MOLNAR David	SRB
9	ŠTURLIĆ Zvonimir	CRO
11	PAVLICA Jovan	SRB
11	BEDEKOVIĆ Ivan	VIND
11	PAPP Barnabas	HUN
11	FLORIJANIĆ Ivica	VIND

Repechage A

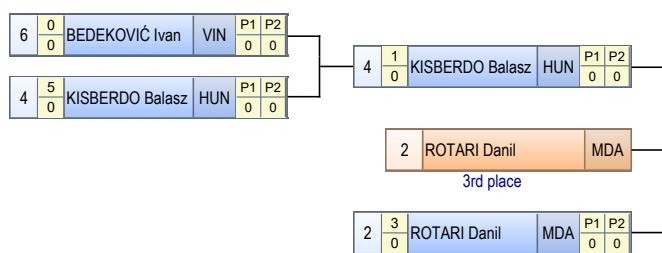

Repechage B

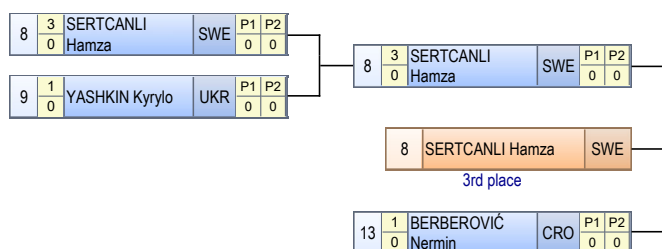

1 - Zlato

JOHANSSON Alexander
2 - Srebro

HAVELKA Ondrej
3 - Bronca

ROTARI Danil

SERTCANLI Hamza

Plasman	Ime	Ekipa	MT	MW	ML	CP	VF	VS	RS	TS	TG
1	JOHANSSON Alexander	SWE	4	4	0	15	0	3	0	0	0
2	HAVELKA Ondrej	CZE	4	3	1	12	0	2	0	0	0
3	ROTARI Danil	MDA	3	2	1	8	1	0	0	0	0
3	SERTCANLI Hamza	SWE	3	2	1	6	0	0	0	0	0
5	KISBERDO Balasz	HUN	4	2	2	9	1	0	0	0	0
5	BERBEROVIĆ Nermin	CRO	4	2	2	9	0	1	0	0	0
7	YASHKIN Kyrylo	UKR	3	1	2	7	1	0	0	0	0
8	CERNOVOL Ilia	MDA	2	1	1	4	0	1	0	0	0
9	MOLNAR David	SRB	1	0	1	1	0	0	0	0	0
9	ŠTURLIĆ Zvonimir	CRO	1	0	1	1	0	0	0	0	0
11	PAVLICA Jovan	SRB	1	0	1	0	0	0	0	0	0
11	BEDEKOVIĆ Ivan	VIND	2	0	2	0	0	0	0	0	0
11	PAPP Barnabas	HUN	1	0	1	0	0	0	0	0	0
11	FLORIJANIĆ Ivica	VIND	1	0	1	0	0	0	0	0	0

MT - matches total, MW - matches won, ML - matches lost, CP - classification points, VF - match victories by fall, VS - match victories by superiority, RS - round victories by superiority, TS - technical points scored, TG - technical points given



DETALJI BORBI

XXVII. Međunarodni Božićni turnir GR

KAD GR 80 kg

129	Q	SRB	MOLNAR David	1	PP	0	0		
		HUN	KISBERDO Balasz	3		0	0		
130	Q	SWE	JOHANSSON Alexander	4	ST	0	0		
		VIND	BEDEKOVIĆ Ivan	0		0	0		
131	Q	CZE	HAVELKA Ondrej	4	ST	0	0		
		SWE	SERTCANLI Hamza	0		0	0		
132	Q	UKR	YASHKIN Kyrylo	5	VT	0	0		
		HUN	PAPP Barnabas	0		0	0		
133	Q	VIND	FLORIJANIĆ Ivica	0	ST	0	0		
		MDA	CERNOVOL Ilija	4		0	0		
134	Q	CRO	BERBEROVIĆ Nermin	3	PP	0	0		
		CRO	ŠTURLIĆ Zvonimir	1		0	0		
149	1/4 F	SRB	PAVLICA Jovan	0	VT	0	0		
		MDA	ROTARI Danil	5		0	0		
150	1/4 F	HUN	KISBERDO Balasz	0	ST	0	0		
		SWE	JOHANSSON Alexander	4		0	0		
151	1/4 F	CZE	HAVELKA Ondrej	4	SP	0	0		
		UKR	YASHKIN Kyrylo	1		0	0		
152	1/4 F	MDA	CERNOVOL Ilija	0	ST	0	0		
		CRO	BERBEROVIĆ Nermin	4		0	0		
161	1/2 F	MDA	ROTARI Danil	0	ST	0	0		
		SWE	JOHANSSON Alexander	4		0	0		
162	1/2 F	CZE	HAVELKA Ondrej	3	PP	0	0		
		CRO	BERBEROVIĆ Nermin	1		0	0		
171	RB1	SWE	SERTCANLI Hamza	3	PP	0	0		
		UKR	YASHKIN Kyrylo	1		0	0		
172	RA1	VIND	BEDEKOVIĆ Ivan	0	VT	0	0		
		HUN	KISBERDO Balasz	5		0	0		
177	F 3-5	SWE	SERTCANLI Hamza	3	PP	0	0		
		CRO	BERBEROVIĆ Nermin	1		0	0		
178	F 3-5	HUN	KISBERDO Balasz	1	PP	0	0		
		MDA	ROTARI Danil	3		0	0		
183	F 1-2	SWE	JOHANSSON Alexander	3	PP	0	0		
		CZE	HAVELKA Ondrej	1		0	0		



TECHNICAL POINTS SUMMARY

XXVII. Međunarodni Božićni turnir GR

KAD GR 80 kg

■ 1 point ■ 2 points ■ 4 points ■ 5 points

1.	JOHANSSON Alexander		SWE	0	(4m)
2.	HAVELKA Ondrej		CZE	0	(4m)
3.	ROTARI Danil		MDA	0	(3m)
3.	SERTCANLI Hamza		SWE	0	(3m)
5.	KISBERDO Balasz		HUN	0	(4m)
5.	BERBEROVIĆ Nermin		CRO	0	(4m)
7.	YASHKIN Kyrylo		UKR	0	(3m)
8.	CERNOVOL Ilia		MDA	0	(2m)
9.	MOLNAR David		SRB	0	(1m)
9.	ŠTURLIĆ Zvonimir		CRO	0	(1m)
11.	PAVLICA Jovan		SRB	0	(1m)
11.	BEDEKOVIĆ Ivan		VIND	0	(2m)
11.	PAPP Barnabas		HUN	0	(1m)
11.	FLORIJANIĆ Ivica		VIND	0	(1m)

0 TOTAL POINTS 17 TOTAL MATCHES 0,0 POINTS PER MATCH



TABLICA ELIMINACIJE

XXVII. Međunarodni Božićni turnir GR

KAD GR 92 kg

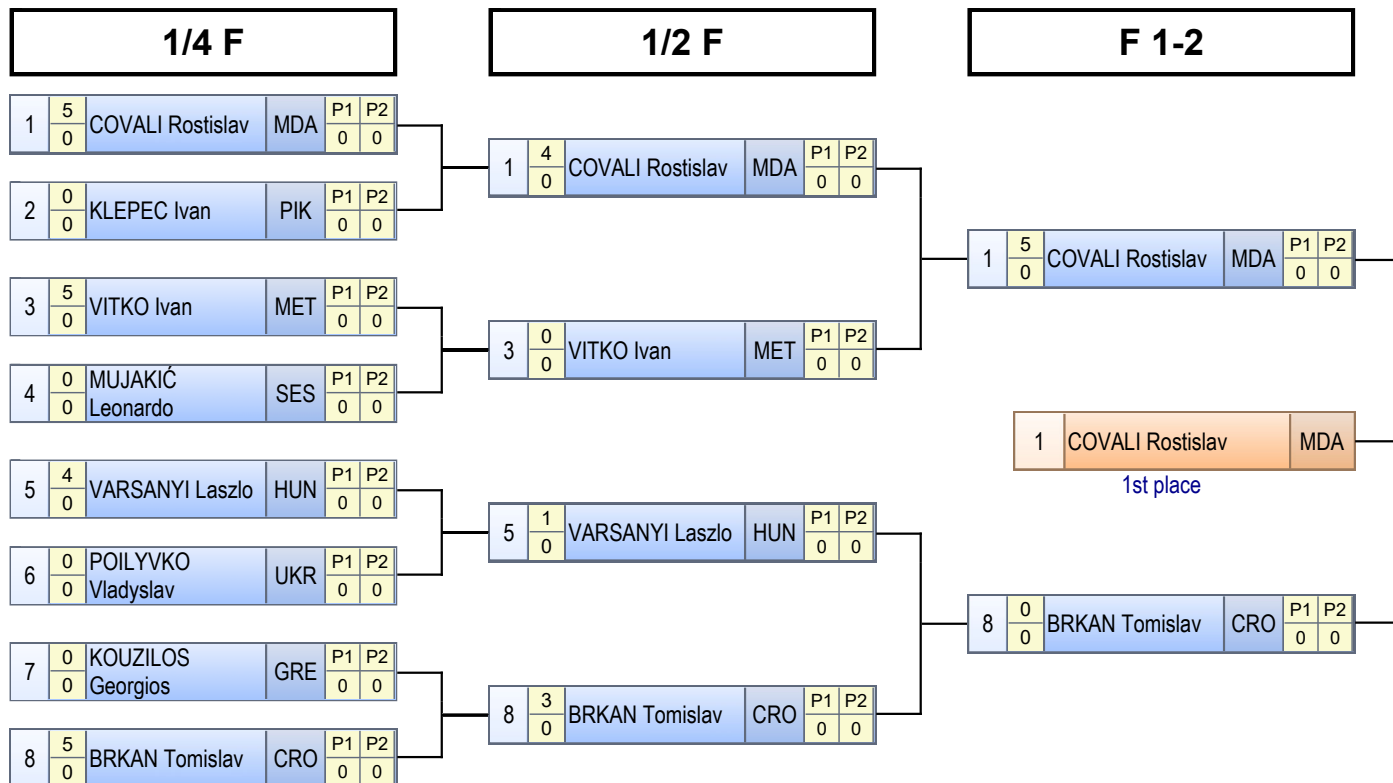

KONAČNI POREDAK

Plasman	Hrvač	Ekipa
1	COVALI Rostislav	MDA
2	BRKAN Tomislav	CRO
3	VITKO Ivan	MET
3	VARSAANYI Laszlo	HUN
5	KLEPEC Ivan	PIKV
5	KOUZILOS Georgios	GRE
7	MUJAKIĆ Leonardo	SES
7	POILYVKO Vladyslav	UKR

Repechage A

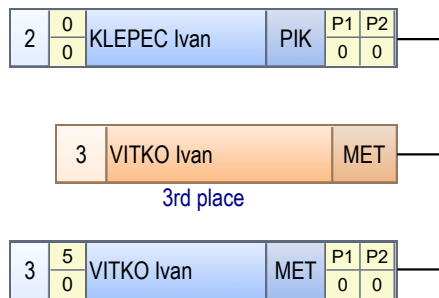

Repechage B

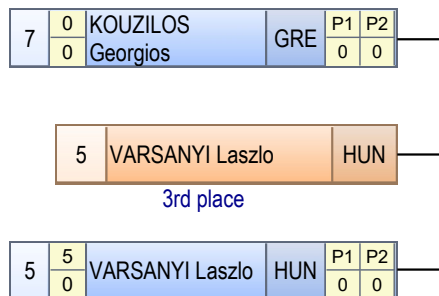

1 - Zlato

COVALI Rostislav

2 - Srebro

BRKAN Tomislav

3 - Bronca

VITKO Ivan



VARSANYI Laszlo

Plasman	Ime	Ekipa	MT	MW	ML	CP	VF	VS	RS	TS	TG
1	COVALI Rostislav	MDA	3	3	0	14	2	1	0	0	0
2	BRKAN Tomislav	CRO	3	2	1	8	1	0	0	0	0
3	VITKO Ivan	MET	3	2	1	10	2	0	0	0	0
3	VARSANYI Laszlo	HUN	3	2	1	10	1	1	0	0	0
5	KLEPEC Ivan	PIKV	2	0	2	0	0	0	0	0	0
5	KOUZILOS Georgios	GRE	2	0	2	0	0	0	0	0	0
7	MUJAKIĆ Leonardo	SES	1	0	1	0	0	0	0	0	0
7	POILYVKO Vladyslav	UKR	1	0	1	0	0	0	0	0	0

MT - matches total, **MW** - matches won, **ML** - matches lost, **CP** - classification points, **VF** - match victories by fall, **VS** - match victories by superiority,
RS - round victories by superiority, **TS** - technical points scored, **TG** - technical points given



DETALJI BORBI

XXVII. Međunarodni Božićni turnir GR

KAD GR 92 kg

137	1/4 F	MDA	COVALI Rostislav	5	VT	0	0		
		PIKV	KLEPEC Ivan	0		0	0		
138	1/4 F	MET	VITKO Ivan	5	VT	0	0		
		SES	MUJAKIĆ Leonardo	0		0	0		
139	1/4 F	HUN	VARSAANYI Laszlo	4	ST	0	0		
		UKR	POILYVKO Vladyslav	0		0	0		
140	1/4 F	GRE	KOUZILLOS Georgios	0	VT	0	0		
		CRO	BRKAN Tomislav	5		0	0		
155	1/2 F	MDA	COVALI Rostislav	4	ST	0	0		
		MET	VITKO Ivan	0		0	0		
156	1/2 F	HUN	VARSAANYI Laszlo	1	PP	0	0		
		CRO	BRKAN Tomislav	3		0	0		
169	F 3-5	GRE	KOUZILLOS Georgios	0	VT	0	0		
		HUN	VARSAANYI Laszlo	5		0	0		
170	F 3-5	PIKV	KLEPEC Ivan	0	VT	0	0		
		MET	VITKO Ivan	5		0	0		
184	F 1-2	MDA	COVALI Rostislav	5	VT	0	0		
		CRO	BRKAN Tomislav	0		0	0		



TECHNICAL POINTS SUMMARY

XXVII. Međunarodni Božićni turnir GR

KAD GR 92 kg

■ 1 point ■ 2 points ■ 4 points ■ 5 points

1.	COVALI Rostislav		MDA	0	(3m)
2.	BRKAN Tomislav		CRO	0	(3m)
3.	VITKO Ivan		MET	0	(3m)
3.	VARSANYI Laszlo		HUN	0	(3m)
5.	KLEPEC Ivan		PIKV	0	(2m)
5.	KOUZILOS Georgios		GRE	0	(2m)
7.	MUJAKIĆ Leonardo		SES	0	(1m)
7.	POILYVKO Vladyslav		UKR	0	(1m)

0 TOTAL POINTS 9 TOTAL MATCHES 0,0 POINTS PER MATCH



TABLICA ELIMINACIJE

XXVII. Međunarodni Božićni turnir GR

KAD GR 110 kg

R.br.	Hrvač	Ekipa	1	2	3	4	5	PP	PL.
1	ČANIĆ Lovro	HRVATSKI DRAGO		4	4	5	0	13	2.
2	RADAK Bertalan	HUNGARY	0		1	5	0	6	4.
3	VACHUDA Lukaš	CZECH REPUBLIC	0	3		5	0	8	3.
4	JAŠAREVSKI Karlo	LIKA	0	0	0		0	0	5.
5	BUBIČIĆ Andrej	CROATIA	5	5	5	5		20	1.

N1

1	4 0	ČANIĆ Lovro	HD	P1 0	P2 0
2	0 0	RADAK Bertalan	HUN	P1 0	P2 0

3	5 0	VACHUDA Lukaš	CZE	P1 0	P2 0
4	0 0	JAŠAREVSKI Karlo	LIK	P1 0	P2 0

N2

5	5 0	BUBIČIĆ Andrej	CRO	P1 0	P2 0
1	0 0	ČANIĆ Lovro	HD	P1 0	P2 0

2	1 0	RADAK Bertalan	HUN	P1 0	P2 0
3	3 0	VACHUDA Lukaš	CZE	P1 0	P2 0

N3

4	0 0	JAŠAREVSKI Karlo	LIK	P1 0	P2 0
1	5 0	ČANIĆ Lovro	HD	P1 0	P2 0

5	5 0	BUBIČIĆ Andrej	CRO	P1 0	P2 0
2	0 0	RADAK Bertalan	HUN	P1 0	P2 0

N4

3	0 0	VACHUDA Lukaš	CZE	P1 0	P2 0
1	4 0	ČANIĆ Lovro	HD	P1 0	P2 0

4	0 0	JAŠAREVSKI Karlo	LIK	P1 0	P2 0
5	5 0	BUBIČIĆ Andrej	CRO	P1 0	P2 0

N5

2	5 0	RADAK Bertalan	HUN	P1 0	P2 0
4	0 0	JAŠAREVSKI Karlo	LIK	P1 0	P2 0

3	0 0	VACHUDA Lukaš	CZE	P1 0	P2 0
5	5 0	BUBIČIĆ Andrej	CRO	P1 0	P2 0

KONAČNI POREDAK

Plasman	Hrvač	Ekipa
1	BUBIČIĆ Andrej	CRO
2	ČANIĆ Lovro	HD
3	VACHUDA Lukaš	CZE
4	RADAK Bertalan	HUN
5	JAŠAREVSKI Karlo	LIKA

1 - Zlato



BUBIČIĆ Andrej

2 - Srebro



ČANIĆ Lovro

3 - Bronca



VACHUDA Lukaš



Plasman	Ime	Ekipa	MT	MW	ML	CP	VF	VS	RS	TS	TG
1	BUBIČIĆ Andrej	CRO	4	4	0	20	4	0	0	0	0
2	ČANIĆ Lovro	HD	4	3	1	13	1	2	0	0	0
3	VACHUDA Lukaš	CZE	4	2	2	8	1	0	0	0	0
4	RADAK Bertalan	HUN	4	1	3	6	1	0	0	0	0
5	JAŠAREVSKI Karlo	LIKA	4	0	4	0	0	0	0	0	0

MT - matches total, MW - matches won, ML - matches lost, CP - classification points, VF - match victories by fall, VS - match victories by superiority, RS - round victories by superiority, TS - technical points scored, TG - technical points given



DETALJI BORBI

XXVII. Međunarodni Božićni turnir GR

KAD GR 110 kg

135	N1	HD	ČANIĆ Lovro	4	ST	0	0		
		HUN	RADAK Bertalan	0		0	0		
136	N1	CZE	VACHUDA Lukaš	5	VT	0	0		
		LIKA	JAŠAREVSKI Karlo	0		0	0		
153	N2	CRO	BUBIČIĆ Andrej	5	VT	0	0		
		HD	ČANIĆ Lovro	0		0	0		
154	N2	HUN	RADAK Bertalan	1	PP	0	0		
		CZE	VACHUDA Lukaš	3		0	0		
163	N3	LIKA	JAŠAREVSKI Karlo	0	VT	0	0		
		HD	ČANIĆ Lovro	5		0	0		
164	N3	CRO	BUBIČIĆ Andrej	5	VT	0	0		
		HUN	RADAK Bertalan	0		0	0		
167	N4	CZE	VACHUDA Lukaš	0	ST	0	0		
		HD	ČANIĆ Lovro	4		0	0		
168	N4	LIKA	JAŠAREVSKI Karlo	0	VT	0	0		
		CRO	BUBIČIĆ Andrej	5		0	0		
173	N5	HUN	RADAK Bertalan	5	VT	0	0		
		LIKA	JAŠAREVSKI Karlo	0		0	0		
174	N5	CZE	VACHUDA Lukaš	0	VT	0	0		
		CRO	BUBIČIĆ Andrej	5		0	0		



TECHNICAL POINTS SUMMARY

XXVII. Međunarodni Božićni turnir GR

KAD GR 110 kg

■ 1 point ■ 2 points ■ 4 points ■ 5 points

1.	BUBIČIĆ Andrej	 CRO	0 (4m)
2.	ČANIĆ Lovro	HD	0 (4m)
3.	VACHUDA Lukaš	 CZE	0 (4m)
4.	RADAK Bertalan	 HUN	0 (4m)
5.	JAŠAREVSKI Karlo	LIKA	0 (4m)

0 TOTAL POINTS 10 TOTAL MATCHES 0,0 POINTS PER MATCH



EKIPNI POREDAK

XXVII. Međunarodni Božićni turnir GR

KAD GR

Place	Team	45 kg	48 kg	51 kg	55 kg	60 kg	65 kg	71 kg	80 kg	92 kg	110 kg	TOTAL
1	CRO	20	9	4	30	36	15	20	14	20	25	193
2	MDA	14	27	25	17		50	10	21	25		189
3	HUN			45	50			14	10	15	12,5	146.5
4	SWE		25	14	6		20	2	40			107
5	SRB	10	30	2	14	25	6	15	4			106
6	UKR	15		15		30	10		8	8		86
7	CZE	8					8		20		15	51
8	GRE					14		21		10		45
9	HER			2		4		25				31
10	ROU	25		2								27
11	HD										20	20
12	LIKA			8							10	18
13	SLAT	10		6								16
14	BUL	15										15
14	MET									15		15
16	ITA						2	10				12
17	PIKV									10		10
18	LUDB					8						8
18	SES									8		8
20	ŠIB						6					6
21	VG			2								2
22	BIH											0
22	GS											0
22	LOK											0
22	MNE											0
22	PETR											0
22	RAV											0
22	SKR											0
22	SLO											0
22	ST											0
22	VIND											0
22	ZD											0