

# MEDITERRANEAN CADET WRESTLING CHAMPIONSHIP



**KANJIZA (SRB)**

**2014-06-09 - 2014-06-15 2014**

**Résultats - Results**

**Lutte Greco-Romaine - Greco-Roman**



**Liste des arbitres / Referee list****Mediterranean Cadet Wrestling Championship**

<b>N°</b>	<b>Licence</b>	<b>Pays Country</b>	<b>Nom - Last Name</b>	<b>Prénom - First Name</b>
		ALG	MEDDAH	Mohamed
		CRO	GRAHOVAC	Josip
		EGY	IBRAHIM	Adel Moustafa
		EGY	MOHAMED	Mahmoud
		FRA	CAUVIN	Sophie
		GRE	GEORGIU	Pavlina
		SLO	SERNEK	Stane
		SRB	BORSOS	Laslo
		SRB	BULJOVIC	Josip
		SRB	LERINC	Rudolf

Nombre d'arbitres - Number of Referee

10











## Liste des nations / Countries List

### Mediterranean Cadet Wrestling Championship

STYLE GR



#### *Pays - Country*

	ALGERIA	ALG
	BOSNIA AND HERZEGOVINA	BIH
	CROATIA	CRO
	EGYPT	EGY
	FRANCE	FRA
	GREECE	GRE
	MOROCCO	MAR
	PORTUGAL	POR
	SERBIA	SRB
	TUNISIA	TUN

Nombre de nations - Number of Countries



**Nombre d'engagés par nation / Number of Entries By Country**

**Mediterranean Cadet Wrestling Championship**

**STYLE GR**



<b>Pays - Country</b>	<b>100 KG</b>	<b>42 KG</b>	<b>46 KG</b>	<b>50 KG</b>	<b>54 KG</b>	<b>58 KG</b>	<b>63 KG</b>	<b>69 KG</b>	<b>76 KG</b>	<b>85 KG</b>	<b>TOTAL</b>
ALG		1		1							2
BIH						1				1	2
CRO	2	1		2	1	1	1	3	1	2	14
EGY								1		1	2
FRA	1				1					1	3
GRE			1	1	2	1	1	1	1	1	9
MAR				1							1
POR							1	1			2
SRB	2	1	1	3	1	2	3	3	1	2	19
TUN						1					1
<b>TOTAL</b>	<b>5</b>	<b>3</b>	<b>2</b>	<b>8</b>	<b>5</b>	<b>6</b>	<b>6</b>	<b>9</b>	<b>3</b>	<b>8</b>	<b>55</b>

**Nombre de nations - Number of Countries** 10



## Liste des Engagés par pays / Entry-List By Country

### Mediterranean Cadet Wrestling Championship

STYLE GR



#### ALGERIA (ALG)

**Lutteur(s) / Wrestler(s) :**

42 kg	BELGHALAM, Habib
50 kg	BOUNASRI, Housseem

#### BOSNIA AND HERZEGOVINA (BIH)

**Lutteur(s) / Wrestler(s) :**

58 kg	HAMZA, Komar
85 kg	MEMIC, Aldijan

#### CROATIA (CRO)

**Entraîneur / Coach :**

KREMIC, Dinko  
BARIC, Andrija

**Lutteur(s) / Wrestler(s) :**

100 kg	MILKOVIC, Ante RUNAC, Petar
42 kg	SACIC, Fran
50 kg	BORECKI, David IVANCIC, Marko
54 kg	BESENIC, Mihael
58 kg	GRUBER, Franko
63 kg	GLASNOVIC, Anton
69 kg	DMITROVIC, Luka KAMENJASEVIC, Antonijo SIROCIC, Jan
76 kg	MAJIC, Tomislav
85 kg	CONAR, Nikola KOPLJAR, Stipo

#### EGYPT (EGY)

**Entraîneur / Coach :**

MOUHAMED, Elashram

**Lutteur(s) / Wrestler(s) :**

69 kg	IBRAHIM, Omar Khalied Shehata Mohamed
85 kg	AHMED, Ahmed Hassan Aly Mahmoud

#### FRANCE (FRA)

**Lutteur(s) / Wrestler(s) :**

100 kg	ZANETON, Luc
--------	--------------



## Liste des Engagés par pays / Entry-List By Country

### Mediterranean Cadet Wrestling Championship

#### STYLE GR



54 kg FERNANE, Anisse  
85 kg GHILMANOV, Kalis

#### GREECE (GRE)

Entraîneur / Coach : ILIADIS, Theodoros

Lutteur(s) / Wrestler(s) :

46 kg ALEXNDROU, Dimitrios  
50 kg RAIKOS, Athanassios  
54 kg BABAHANIAN, Armen  
KOUTSOURIDIS, Mihalis  
58 kg BAFRALIS, Christos  
63 kg DAMIANAKIS, Nikos  
69 kg VAHLAS, Konstantinos  
76 kg HARALAMBIDIS, Athanassios  
85 kg DOUDA, Mateo

#### MOROCCO (MAR)

Lutteur(s) / Wrestler(s) :

50 kg HANINE, AYOUB

#### PORTUGAL (POR)

Entraîneur / Coach : FONTES, Luis

Lutteur(s) / Wrestler(s) :

63 kg CALDAS, Daniel  
69 kg CALDAS, Pedro

#### SERBIA (SRB)

Lutteur(s) / Wrestler(s) :

100 kg BOZSO, Tamas  
PESUT, Djordje  
42 kg KOVAC, Srdjan  
46 kg KATONA, Adam  
50 kg GAN, Djoko  
KOLOMPAR, Sebastian  
PETROVIC, Dejan  
54 kg NADJ, Sebastian  
58 kg KARAMARKOVIC, Dalibor  
POLGAR, Akos



Liste des Engagés par pays / Entry-List By Country

Mediterranean Cadet Wrestling Championship

STYLE GR



63 kg	DJORDJEVIC, Damljan ERSKI, Aleksa FEKETE, Erik
69 kg	COLIC, Danilo SEVIC, Djordje VRABEL, Akos
76 kg	ALMASI, Bence
85 kg	KALABA, Jovan MILOJEVIC, Janko

**TUNISIA (TUN)**

**Entraîneur / Coach :** MOHAMED NABIL, B. KRAIEM

**Lutteur(s) / Wrestler(s) :**

58 kg SOLAYMEN, NASR



# Feuille de compétition / Competition Sheet

## Mediterranean Cadet Wrestling Championship



**STYLE : GR 100 kg**

**TOUR : 1**

1	4 8	ZANETON Luc (FRA)	P1	P2	P3	} 1	<b>ZANETON Luc (FRA)</b>
			8	0	0		
2	0 0	MILKOVIC Ante (CRO)	P1	P2	P3		
			0	0	0		
3	4 4	PESUT Djordje (SRB)	P1	P2	P3	} 3	<b>PESUT Djordje (SRB)</b>
			4	0	0		
4	0 0	RUNAC Petar (CRO)	P1	P2	P3		
			0	0	0		

**TOUR : 2**

5	0 0	BOZSO Tamas (SRB)	P1	P2	P3	} 1	<b>ZANETON Luc (FRA)</b>
			0	0	0		
1	4 10	ZANETON Luc (FRA)	P1	P2	P3		
			10	0	0		
2	0 0	MILKOVIC Ante (CRO)	P1	P2	P3	} 3	<b>PESUT Djordje (SRB)</b>
			0	0	0		
3	3 0	PESUT Djordje (SRB)	P1	P2	P3		
			0	0	0		

**TOUR : 3**

4	0 0	RUNAC Petar (CRO)	P1	P2	P3	} 1	<b>ZANETON Luc (FRA)</b>
			0	0	0		
1	4 9	ZANETON Luc (FRA)	P1	P2	P3		
			9	0	0		
5	1 1	BOZSO Tamas (SRB)	P1	P2	P3	} 2	<b>MILKOVIC Ante (CRO)</b>
			1	0	0		
2	4 9	MILKOVIC Ante (CRO)	P1	P2	P3		
			9	0	0		

**TOUR : 4**

3	1 1	PESUT Djordje (SRB)	P1	P2	P3	} 1	<b>ZANETON Luc (FRA)</b>
			1	0	0		
1	4 10	ZANETON Luc (FRA)	P1	P2	P3		
			10	0	0		
4	0 0	RUNAC Petar (CRO)	P1	P2	P3	} 5	<b>BOZSO Tamas (SRB)</b>
			0	0	0		
5	4 6	BOZSO Tamas (SRB)	P1	P2	P3		
			6	0	0		

**TOUR : 5**

2	4 5	MILKOVIC Ante (CRO)	P1	P2	P3	} 2	<b>MILKOVIC Ante (CRO)</b>
			5	0	0		
4	0 0	RUNAC Petar (CRO)	P1	P2	P3		
			0	0	0		
3	1 1	PESUT Djordje (SRB)	P1	P2	P3	} 5	<b>BOZSO Tamas (SRB)</b>
			1	0	0		
5	3 2	BOZSO Tamas (SRB)	P1	P2	P3		
			2	0	0		

### Classement

Cl	Pays	Nom	Points
1	FRA	ZANETON Luc	16
2	SRB	PESUT Djordje	9
3	CRO	MILKOVIC Ante	8
4	SRB	BOZSO Tamas	8
5	CRO	RUNAC Petar	0



## Classement

### Mediterranean Cadet Wrestling Championship

STYLE : GR 100 kg



1 - Or / Gold



ZANETON Luc

2 - Argent / Silver



PESUT Djordje

3 - Bronze



MILKOVIC Ante

Classement	Nom - Name	Pays - Country	Points
1	ZANETON Luc	FRA	16
2	PESUT Djordje	SRB	9
3	MILKOVIC Ante	CRO	8
4	BOZSO Tamas	SRB	8
5	RUNAC Petar	CRO	0



# Feuille de compétition / Competition Sheet

## Mediterranean Cadet Wrestling Championship

STYLE : GR 42 kg



### TOUR : 1

1	$\frac{3}{9}$	BELGHALAM Habib (ALG)	P1	P2	P3	1	BELGHALAM Habib (ALG)
			9	0	0		
2	$\frac{1}{7}$	SACIC Fran (CRO)	P1	P2	P3		
			7	0	0		

### TOUR : 2

3	$\frac{4}{6}$	KOVAC Srdjan (SRB)	P1	P2	P3	3	KOVAC Srdjan (SRB)
			6	0	0		
1	$\frac{0}{0}$	BELGHALAM Habib (ALG)	P1	P2	P3		
			0	0	0		

### TOUR : 3

2	$\frac{4}{8}$	SACIC Fran (CRO)	P1	P2	P3	2	SACIC Fran (CRO)
			8	0	0		
3	$\frac{0}{4}$	KOVAC Srdjan (SRB)	P1	P2	P3		
			4	0	0		

### Classement

Cl	Pays	Nom	Points
1	CRO	SACIC Fran	5
2	SRB	KOVAC Srdjan	4
3	ALG	BELGHALAM Habib	3



**Classement**

**Mediterranean Cadet Wrestling Championship**



STYLE : GR 42 kg

1 - Or / Gold



SACIC Fran

2 - Argent / Silver



KOVAC Srdjan

3 - Bronze



BELGHALAM Habib

<i>Classement</i>	<i>Nom - Name</i>	<i>Pays - Country</i>	<i>Points</i>
1	SACIC Fran	CRO	5
2	KOVAC Srdjan	SRB	4
3	BELGHALAM Habib	ALG	3



# Feuille de compétition / Competition Sheet

## Mediterranean Cadet Wrestling Championship

STYLE : GR 46 kg



**TOUR : 1**

1	<table border="1"><tr><td>1</td></tr><tr><td>1</td></tr></table>	1	1	ALEXNDROU D. (GRE)	<table border="1"><tr><td>P1</td><td>P2</td><td>P3</td></tr><tr><td>1</td><td>0</td><td>0</td></tr></table>	P1	P2	P3	1	0	0	2	KATONA Adam (SRB)
1													
1													
P1	P2	P3											
1	0	0											
2	<table border="1"><tr><td>3</td></tr><tr><td>6</td></tr></table>	3	6	KATONA Adam (SRB)	<table border="1"><tr><td>P1</td><td>P2</td><td>P3</td></tr><tr><td>6</td><td>0</td><td>0</td></tr></table>	P1	P2	P3	6	0	0		
3													
6													
P1	P2	P3											
6	0	0											

### Classement

Cl	Pays	Nom	Points
1	SRB	KATONA Adam	3
2	GRE	ALEXNDROU Dimitrios	1



**Classement**

**Mediterranean Cadet Wrestling Championship**



STYLE : GR 46 kg

1 - Or / Gold



KATONA Adam

2 - Argent / Silver



ALEXNDROU Dimitrios

3 - Bronze



<i>Classement</i>	<i>Nom - Name</i>	<i>Pays - Country</i>	<i>Points</i>
1	KATONA Adam	SRB	3
2	ALEXNDROU Dimitrios	GRE	1



# Feuille de compétition / Competition Sheet

## Mediterranean Cadet Wrestling Championship



**STYLE : GR 50 kg**

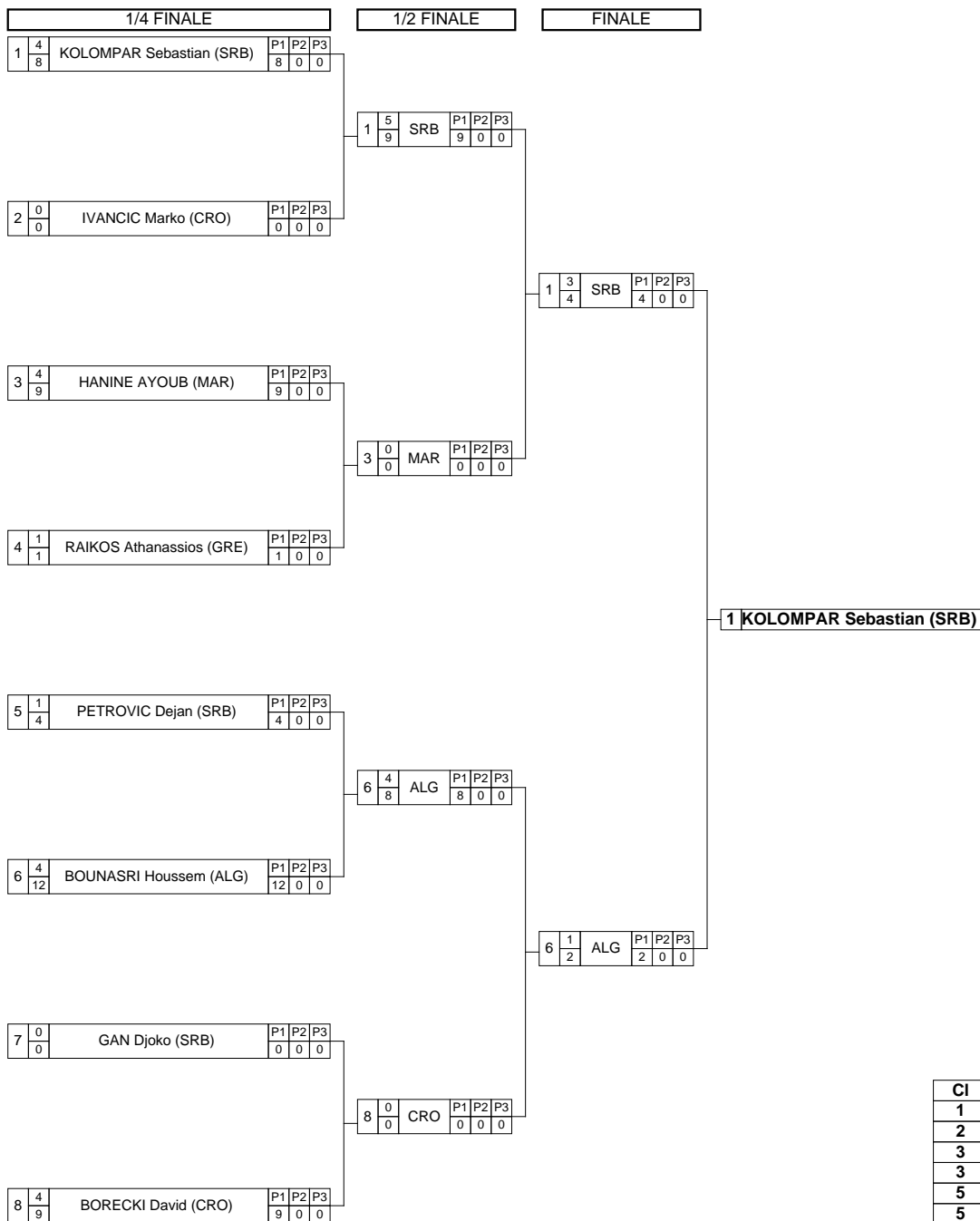

**Classement**

Cl	Pays	Nom
1	SRB	KOLOMPAR Sebastian
2	ALG	BOUNASRI Housseem
3	MAR	HANINE AYOUB
3	CRO	BORECKI David
5	CRO	IVANCIC Marko
5	SRB	PETROVIC Dejan
7	GRE	RAIKOS Athanassios
8	SRB	GAN Djoko

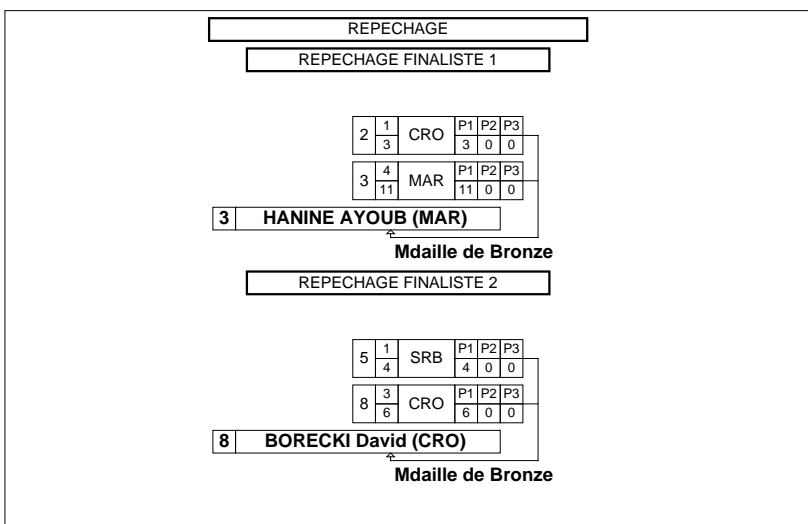



## Classement

### Mediterranean Cadet Wrestling Championship



STYLE : GR 50 kg

1 - Or / Gold



KOLOMPAR Sebastian

2 - Argent / Silver



BOUNASRI Housseem

3 - Bronze



HANINE AYOUB



BORECKI David

Classement	Nom - Name	Pays - Country
1	KOLOMPAR Sebastian	SRB
2	BOUNASRI Housseem	ALG
3	HANINE AYOUB	MAR
3	BORECKI David	CRO
5	IVANCIC Marko	CRO
5	PETROVIC Dejan	SRB
7	RAIKOS Athanassios	GRE
8	GAN Djoko	SRB



# Feuille de compétition / Competition Sheet

## Mediterranean Cadet Wrestling Championship



**STYLE : GR 54 kg**

**TOUR : 1**

1	3 11	KOUTSOURIDIS M. (GRE)	P1	P2	P3	} <b>1 KOUTSOURIDIS M. (GRE)</b>
			11	0	0	
2	1 9	FERNANE Anisse (FRA)	P1	P2	P3	
			9	0	0	
3	4 5	NADJ Sebastian (SRB)	P1	P2	P3	} <b>3 NADJ Sebastian (SRB)</b>
			5	0	0	
4	0 4	BESENIC Mihael (CRO)	P1	P2	P3	
			4	0	0	

**TOUR : 2**

5	1 2	BABAHANIAN Armen (GRE)	P1	P2	P3	} <b>1 KOUTSOURIDIS M. (GRE)</b>
			2	0	0	
1	3 2	KOUTSOURIDIS M. (GRE)	P1	P2	P3	
			2	0	0	
2	0 0	FERNANE Anisse (FRA)	P1	P2	P3	} <b>3 NADJ Sebastian (SRB)</b>
			0	0	0	
3	4 9	NADJ Sebastian (SRB)	P1	P2	P3	
			9	0	0	

**TOUR : 3**

4	1 4	BESENIC Mihael (CRO)	P1	P2	P3	} <b>1 KOUTSOURIDIS M. (GRE)</b>
			4	0	0	
1	3 5	KOUTSOURIDIS M. (GRE)	P1	P2	P3	
			5	0	0	
5	3 4	BABAHANIAN Armen (GRE)	P1	P2	P3	} <b>5 BABAHANIAN Armen (GRE)</b>
			4	0	0	
2	0 0	FERNANE Anisse (FRA)	P1	P2	P3	
			0	0	0	

**TOUR : 4**

3	4 9	NADJ Sebastian (SRB)	P1	P2	P3	} <b>3 NADJ Sebastian (SRB)</b>
			9	0	0	
1	0 0	KOUTSOURIDIS M. (GRE)	P1	P2	P3	
			0	0	0	
4	3 6	BESENIC Mihael (CRO)	P1	P2	P3	} <b>4 BESENIC Mihael (CRO)</b>
			6	0	0	
5	1 2	BABAHANIAN Armen (GRE)	P1	P2	P3	
			2	0	0	

**TOUR : 5**

2	0 4	FERNANE Anisse (FRA)	P1	P2	P3	} <b>4 BESENIC Mihael (CRO)</b>
			4	0	0	
4	4 10	BESENIC Mihael (CRO)	P1	P2	P3	
			10	0	0	
3	4 11	NADJ Sebastian (SRB)	P1	P2	P3	} <b>3 NADJ Sebastian (SRB)</b>
			11	0	0	
5	1 2	BABAHANIAN Armen (GRE)	P1	P2	P3	
			2	0	0	

### Classement

Cl	Pays	Nom	Points
1	SRB	NADJ Sebastian	16
2	GRE	KOUTSOURIDIS M.	9
3	CRO	BESENIC Mihael	8
4	GRE	BABAHANIAN Armen	6
5	FRA	FERNANE Anisse	1



**Classement**

**Mediterranean Cadet Wrestling Championship**



STYLE : GR 54 kg

1 - Or / Gold



NADJ Sebastian

2 - Argent / Silver



KOUTSOURIDIS Mihalis

3 - Bronze



BESENIC Mihael

<i>Classement</i>	<i>Nom - Name</i>	<i>Pays - Country</i>	<i>Points</i>
1	NADJ Sebastian	SRB	16
2	KOUTSOURIDIS M.	GRE	9
3	BESENIC Mihael	CRO	8
4	BABAHANIAN Armen	GRE	6
5	FERNANE Anisse	FRA	1



# Feuille de compétition / Competition Sheet

## Mediterranean Cadet Wrestling Championship



STYLE : GR 58 kg

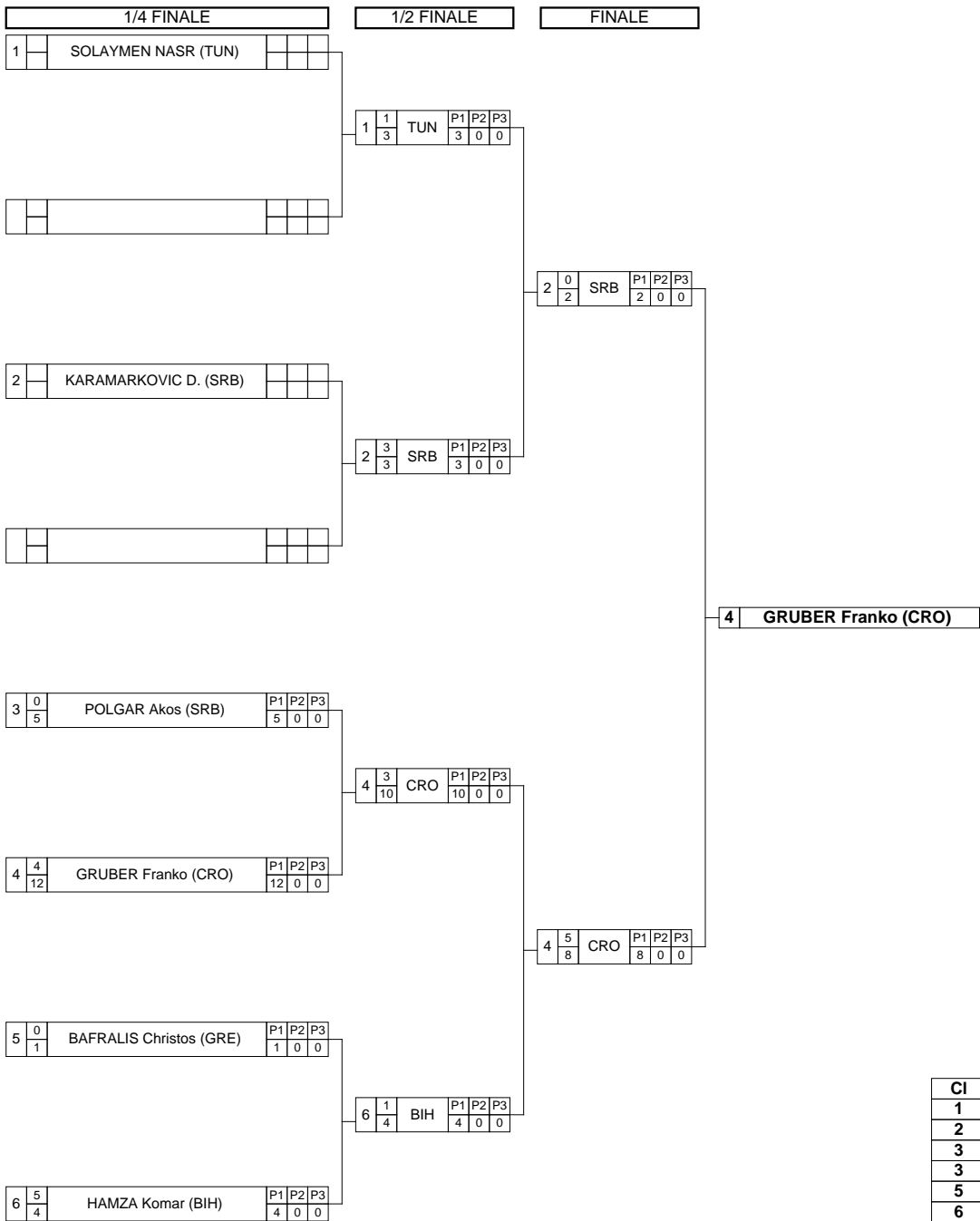

Classement

Cl	Pays	Nom
1	CRO	GRUBER Franko
2	SRB	KARAMARKOVIC Dalibor
3	TUN	SOLAYMEN NASR
3	SRB	POLGAR Akos
5	BIH	HAMZA Komar
6	GRE	BAFRALIS Christos

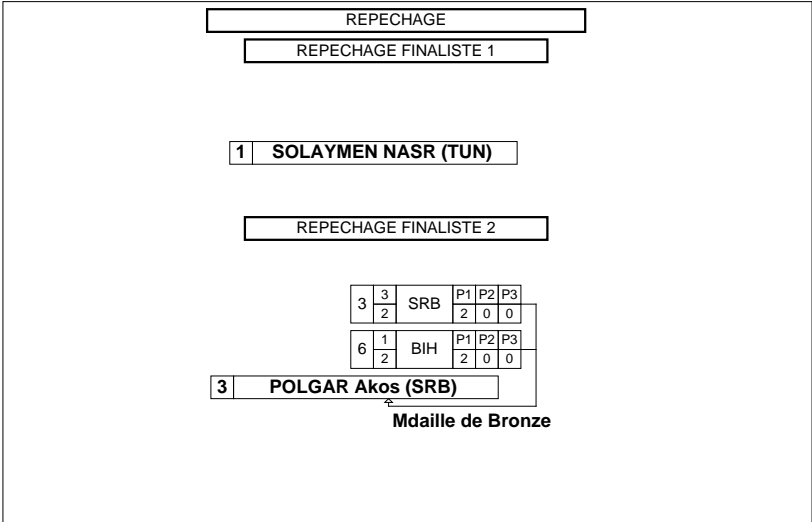



**Classement**

**Mediterranean Cadet Wrestling Championship**



STYLE : GR 58 kg

1 - Or / Gold



GRUBER Franko

2 - Argent / Silver



KARAMARKOVIC Dalibor

3 - Bronze



SOLAYMEN NASR



POLGAR Akos

<i>Classement</i>	<i>Nom - Name</i>	<i>Pays - Country</i>
1	GRUBER Franko	CRO
2	KARAMARKOVIC D.	SRB
3	SOLAYMEN NASR	TUN
3	POLGAR Akos	SRB
5	HAMZA Komar	BIH
6	BAFRALIS Christos	GRE



# Feuille de compétition / Competition Sheet

## Mediterranean Cadet Wrestling Championship



STYLE : GR 63 kg

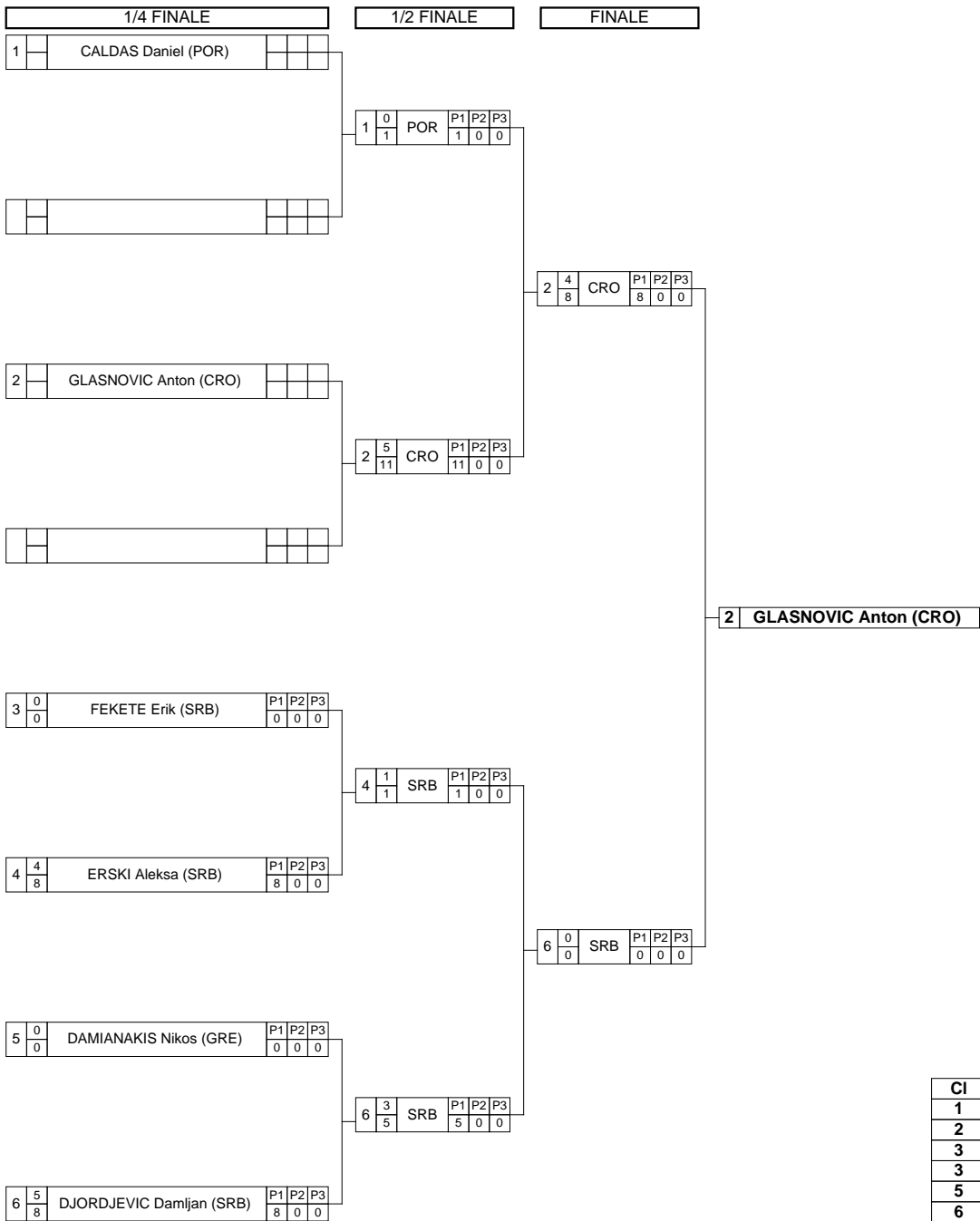

**Classement**

Cl	Pays	Nom
1	CRO	GLASNOVIC Anton
2	SRB	DJORDJEVIC Damijan
3	POR	CALDAS Daniel
3	SRB	ERSKI Aleksa
5	GRE	DAMIANAKIS Nikos
6	SRB	FEKETE Erik

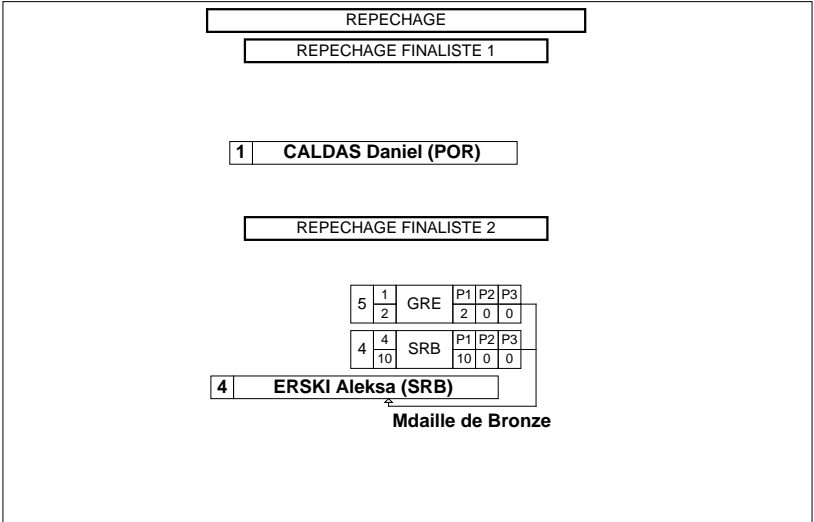



**Classement**

**Mediterranean Cadet Wrestling Championship**



STYLE : GR 63 kg

1 - Or / Gold



GLASNOVIC Anton

2 - Argent / Silver



DJORDJEVIC Damljan

3 - Bronze



CALDAS Daniel



ERSKI Aleksa

<i>Classement</i>	<i>Nom - Name</i>	<i>Pays - Country</i>
1	GLASNOVIC Anton	CRO
2	DJORDJEVIC Damljan	SRB
3	CALDAS Daniel	POR
3	ERSKI Aleksa	SRB
5	DAMIANAKIS Nikos	GRE
6	FEKETE Erik	SRB



# Feuille de compétition / Competition Sheet

## Mediterranean Cadet Wrestling Championship



**STYLE : GR 69 kg**



### Classement

Cl	Pays	Nom
1	CRO	KAMENJASEVIC Antonijo
2	SRB	VRABEL Akos
3	CRO	DMITROVIC Luka
3	EGY	IBRAHIM Omar Khalied Shehata Moh
5	POR	CALDAS Pedro
5	GRE	VAHLAS Konstantinos
7	SRB	SEVIC Djordje
8	CRO	SIROCIC Jan
9	SRB	COLIC Danilo

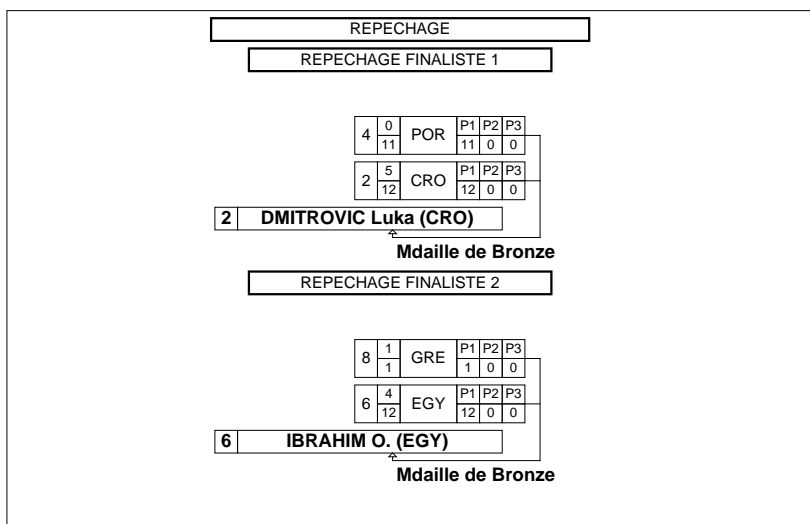



**Classement**

**Mediterranean Cadet Wrestling Championship**



STYLE : GR 69 kg

1 - Or / Gold



KAMENJASEVIC Antonijo

2 - Argent / Silver



VRABEL Akos

3 - Bronze



DMITROVIC Luka IBRAHIM Omar Khalied Shehata Mohamed

Classement	Nom - Name	Pays - Country
1	KAMENJASEVIC A.	CRO
2	VRABEL Akos	SRB
3	DMITROVIC Luka	CRO
3	IBRAHIM O.	EGY
5	CALDAS Pedro	POR
5	VAHLAS Konstantinos	GRE
7	SEVIC Djordje	SRB
8	SIROCIC Jan	CRO
9	COLIC Danilo	SRB



# Feuille de compétition / Competition Sheet

## Mediterranean Cadet Wrestling Championship

STYLE : GR 76 kg



**TOUR : 1**

1	$\frac{3}{6}$	HARALAMBIDIS A. (GRE)	P1	P2	P3	1	HARALAMBIDIS A. (GRE)
			6	0	0		
2	$\frac{0}{0}$	ALMASI Bence (SRB)	P1	P2	P3		
			0	0	0		

**TOUR : 2**

3	$\frac{4}{2}$	MAJIC Tomislav (CRO)	P1	P2	P3	3	MAJIC Tomislav (CRO)
			2	0	0		
1	$\frac{0}{0}$	HARALAMBIDIS A. (GRE)	P1	P2	P3		
			0	0	0		

**TOUR : 3**

2	$\frac{1}{1}$	ALMASI Bence (SRB)	P1	P2	P3	3	MAJIC Tomislav (CRO)
			1	0	0		
3	$\frac{4}{9}$	MAJIC Tomislav (CRO)	P1	P2	P3		
			9	0	0		

### Classement

Cl	Pays	Nom	Points
1	CRO	MAJIC Tomislav	8
2	GRE	HARALAMBIDIS A.	3
3	SRB	ALMASI Bence	1



**Classement**

**Mediterranean Cadet Wrestling Championship**



STYLE : GR 76 kg

1 - Or / Gold



MAJIC Tomislav

2 - Argent / Silver



HARALAMBIDIS Athanassios

3 - Bronze



ALMASI Bence

<i>Classement</i>	<i>Nom - Name</i>	<i>Pays - Country</i>	<i>Points</i>
1	MAJIC Tomislav	CRO	8
2	HARALAMBIDIS A.	GRE	3
3	ALMASI Bence	SRB	1



# Feuille de compétition / Competition Sheet

## Mediterranean Cadet Wrestling Championship



STYLE : GR 85 kg



Classement

Cl	Pays	Nom
1	EGY	AHMED Ahmed Hassan Aly Mahmoud
2	CRO	KOPLJAR Stipo
3	CRO	CONAR Nikola
3	FRA	GHILMANOV Kalis
5	SRB	KALABA Jovan
5	GRE	DOUDA Mateo
7	SRB	MILOJEVIC Janko
8	BIH	MEMIC Aldijan

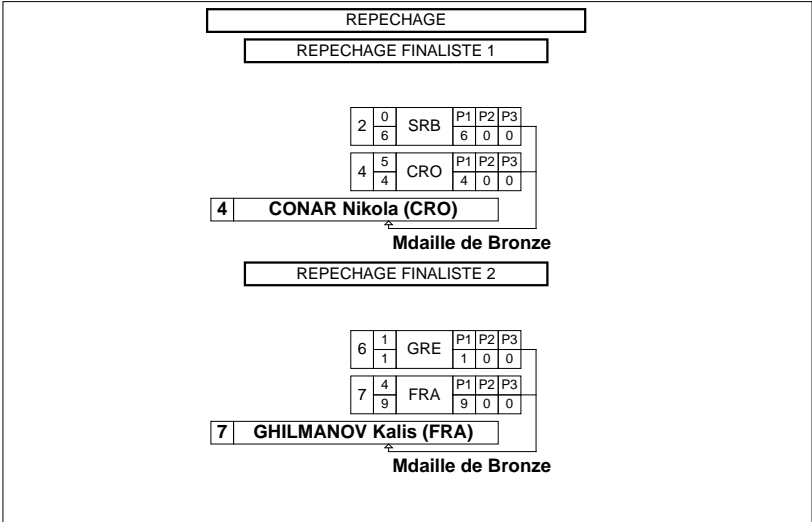



**Classement**

**Mediterranean Cadet Wrestling Championship**



STYLE : GR 85 kg

1 - Or / Gold



AHMED Ahmed Hassan Aly Mahmoud

2 - Argent / Silver



KOPLJAR Stipo

3 - Bronze



CONAR Nikola



GHILMANOV Kalis

<i>Classement</i>	<i>Nom - Name</i>	<i>Pays - Country</i>
1	AHMED A.	EGY
2	KOPLJAR Stipo	CRO
3	CONAR Nikola	CRO
3	GHILMANOV Kalis	FRA
5	KALABA Jovan	SRB
5	DOUDA Mateo	GRE
7	MILOJEVIC Janko	SRB
8	MEMIC Aldijan	BIH



## MEDITERANEAN CHAMPIONSHIP (SRB)

### TEAMS RANKINGS

### GR - CADET

Rasnk.	Nation	42	46	50	54	58	63	69	76	85	100	TOTAL
1	SRB	9	10	10	10	9	9	9	8	6	9	89
2	CRO	10		8	8	10	10	10	10	9	8	83
3	GRE		9	6	9	5	6	6	9	5		55
4	FRA				6					8	10	24
5	EGY							8		10		18
5	ALG	8		9								17
7	POR						8	6				14
8	BIH					6				3		9
9	MAR			8								8
10	TUN					8						8